

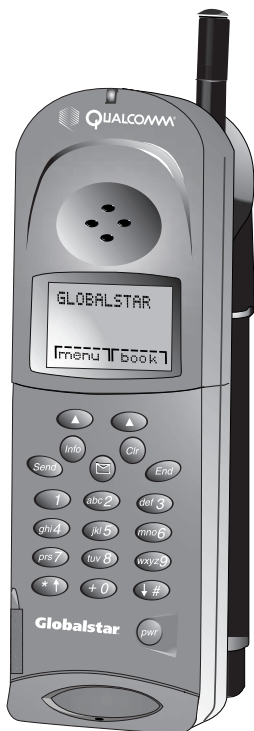

QUALCOMM Globalstar GSP-1600 Tri-Mode Phone User Guide



Globalstar



This guide is based on the production version of the QUALCOMM Globalstar GSP-1600 Tri-Mode. Software changes may have occurred after this printing.

QUALCOMM reserves the right to make changes in technical and product specifications without prior notice.

QUALCOMM Incorporated
5775 Morehouse Drive, San Diego, CA 92121-1714
Document Number 80-98153-2EN Rev. A

Copyright© 2001 QUALCOMM® Incorporated
All rights reserved

This technology was exported from the United States Government. Diversion contrary to U.S. law prohibited.

QUALCOMM® is a registered trademark of QUALCOMM Incorporated.
Digital by QUALCOMM® is a registered trademark of QUALCOMM Incorporated.
SMART KEY™ is a trademark of QUALCOMM Incorporated.
Globalstar™ is a trademark of Loral Qualcomm Satellite Services, Inc.

All other trademarks and registered trademarks are the property of their respective owners.

Printed in the United States of America

Cautions and Warnings	v
Getting Started	1
Understanding your phone	1
Contacting customer service	1
Solving problems.....	2
Understanding this guide.....	2
Manually selecting call mode	2
Preparing for satellite calls	2
Making satellite calls	4
Making cellular calls	4
Making data calls	5
Receiving satellite or cellular calls	5
Ending calls.....	6
Displaying your phone number.....	6
Phone Basics	7
Phone features and keypad.....	7
Display indicators	9
Information key	10
Security module	10
Antenna.....	11
Calling Basics	13
Turning the phone on and off.....	13
Standby mode	14
Power save mode.....	14
Entering numbers.....	14
Making emergency calls	15
Redialing a call	17
Muting a call	17
Possible service provider services	17

Menu Basics	19
Accessing the Main Menu	20
Navigating and using menus	20
Phone Book Menu	21
Entering letters and other characters	21
Entering pauses	22
Saving entries	23
Finding entries.....	24
Editing entries	24
Erasing entries	25
Using the “secret” feature	25
Viewing numbers	26
Sending tones.....	26
Prepending numbers	27
Speed dialing.....	27
Call History Menu	29
Accessing the call history list.....	30
Viewing call history details.....	30
Messages Menu	33
Message alerts	33
Reading Messages.....	33
Voice messages.....	33
Text messages.....	35
Features Menu	39
Key Guard	39
Scratchpad	39
Current position coordinates.....	40
Data speed.....	41
Call Information Menu.....	43
Last Call.....	43
Home Calls.....	43
Roam Calls	44
Recent Calls	44

Data Calls	44
All Calls.....	44
Resetting call counters	45
Security Menu	47
Lock code	47
Locking the phone.....	48
Restricting the phone	48
Entering priority numbers	49
Erasing call history list	49
Erasing phone book entries.....	49
Erasing SMS messages	50
Resetting preferences	50
Entering PIN.....	50
Preferences Menu	53
Sounds	53
Display	56
SMS Time.....	61
Language.....	61
Alerts	61
Calling	63
System Menu	67
Status	67
Find Home.....	68
Version	69
Service Provider Select.....	69
Service Provider	72
Territory	72
Manual Mode	72
Auto Mode	73
NAM Select	76
My Numbers	77
Battery Care and Maintenance.....	79
Battery care and charging.....	79
Battery chargers	80
Low battery	81

Battery removal	81
Battery replacement	81
Safety Information	83
Exposure to radio frequency signals	83
Antenna care	84
Phone operation	84
Driving	84
Electronic devices	84
Aircraft	85
Blasting areas	85
Potentially explosive atmospheres	85
For vehicles equipped with an air bag	86
Battery care	86
Other safety issues	86
Accessories	87
Battery	87
Leather case	87
AC wall charger	87
Universal travel charger	87
Cigarette lighter adapter	87
Data cables	87
Hands-free car kit	88
Troubleshooting	89
Appendix	93
Third Party Equipment	93

Cautions and Warnings



Warning

Only use the batteries, antennas, and chargers provided by QUALCOMM. The use of any other type may be dangerous.



Warning

Allow only authorized personnel to service the phone and its accessories. Unauthorized service can invalidate the warranty.



Caution

Any changes or modifications to this equipment not expressly approved in this document could void your warranty and your authority to operate this equipment.



Caution

Avoid exposing the phone and accessories to rain or other liquids. If the telephone gets wet, turn the power off immediately and remove the battery pack. See Battery Care and Maintenance, page 79, for more information.



Note

When using the QUALCOMM Globalstar Tri-Mode phone near a television or radio, the phone can cause interference. Regulatory agencies in your area, such as the United States Federal Communications Commission (FCC) or Canadian Industry Canada (IC), can require you to stop using the phone if such interference cannot be eliminated. If you need assistance, contact your satellite or cellular service provider.

Cautions and Warnings

It is *very* important that you become familiar with this section because your tri-mode phone is unique – it combines satellite technology and cellular technology in one phone.

This section provides information on the following basic concepts:

- Understanding your phone
- Contacting customer service
- Solving problems
- Understanding this guide
- Manually selecting call mode
- Preparing for satellite calls
- Making satellite calls
- Making cellular calls
- Making data calls
- Receiving satellite or cellular calls
- Ending calls
- Displaying your phone number

For more detailed information on usage, refer to other sections in this guide. If you need further assistance, see *Solving problems*, page 2.

Understanding your phone

Consider your phone as “two phones in one” because it requires operation in two distinct modes to make and receive two different types of calls:

- Satellite calls – Calls made via satellite. This is known as Globalstar satellite mode.
- Cellular calls – Calls made by cellular phone technology. There are two cellular modes: digital and analog.



Note

The calling mode has probably been preset on your phone. To view or change the current setting, set your mode preference (see *Auto Mode*, page 73) so that the mode is automatically selected when you turn your phone on (see *Manual Mode*, page 72).

Contacting customer service







You may have different service providers for Globalstar satellite service and cellular service. Contact the appropriate service provider for customer service.

Solving problems

If you have problems using your phone, see **Troubleshooting**, page 89. If the problems are not resolved, contact your satellite or cellular service provider.

Understanding this guide

These conventions or representations are used in this guide:

Type of Action	Example	Action
Key Presses	Press  .	Press key briefly.
	Press and hold  .	Press key for more than one second.
Using SMART KEY™ options	Press  book .	Press the SMART KEY button  under the appropriate option on the screen.
Scrolling	Scroll to select “yes” or “no.”	Press either of the volume buttons (on the side of the phone) or the  and  keys.

Manually selecting call mode

When ready to make a call, you can quickly select the call mode you prefer: Globalstar, cellular (digital or analog), or Auto Mode. When Auto Mode is selected, the phone searches for service as specified by the Auto Mode setting. (See **Auto Mode**, page 73.)

To manually select a call mode

1. On the keypad, press and hold  to display the mode menu.
2. Press the menu number of the appropriate call mode.

Preparing for satellite calls

- If the security module is not properly installed, only calls to emergency numbers can be made; calls cannot be received. Your satellite service provider installs and maintains the security module (see **Information key**, page 10, for more information).
- Charge and properly install the battery. For more information, refer to **Battery Care and Maintenance**, page 79.
- Rotate the Globalstar satellite antenna located on the back of the phone (see **Phone features and keypad**, page 7). The antenna will automatically extend as you rotate it and automatically retract when stored.

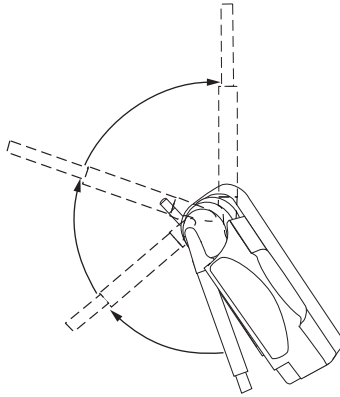

- Move the antenna to its optimal position (pointing straight up to the sky) until it sets into one of three positions. You cannot make or receive a satellite call with the Globalstar satellite antenna stored. The following shows correct and incorrect antenna positions when making satellite calls:



- The phone does not operate inside a building or a vehicle unless you are using the car kit.
- To prevent dropped calls, move outdoors so that you can see the whole sky and have direct access to the satellite. If a call is dropped, a “fade alert” sounds (to verify that this feature is turned on, see Fade, page 62).
- For best performance, move away from tall obstacles such as buildings or trees.

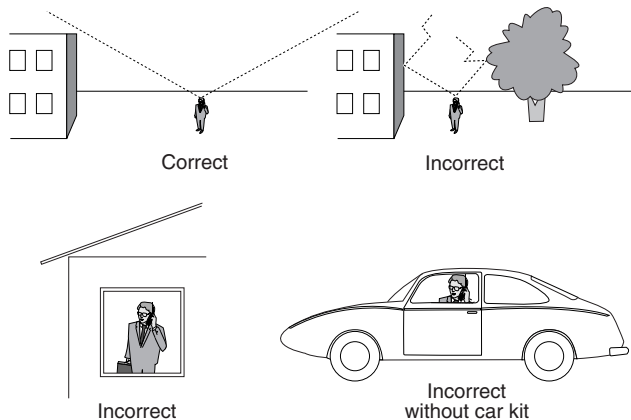

- You can, however, attempt to make cellular calls in all of the above locations.

Making satellite calls

1. Rotate the satellite antenna (see Preparing for satellite calls, page 2).
2. Press and hold **(Pwr)** to turn the phone on.
3. Select call mode, if necessary (see Manually selecting call mode, page 2).



Note

The roaming indicator () usually displays immediately if the network roams to find a satellite service provider.

4. Enter the phone number that you want to call (see Entering numbers, page 14). To make international calls, see International dialing, page 17.



Note

When using the keypad or viewing the screen in Globalstar satellite mode, keep the antenna pointing up to maintain service.

5. Press **(SEND)**.
A message displays if the phone is locked, the phone number is restricted, or there is another problem.

Making cellular calls

1. To turn the phone on, press and hold **(Pwr)**.
2. Select call mode, if necessary (see Manually selecting call mode, page 2).

3. Fully extend the cellular antenna.

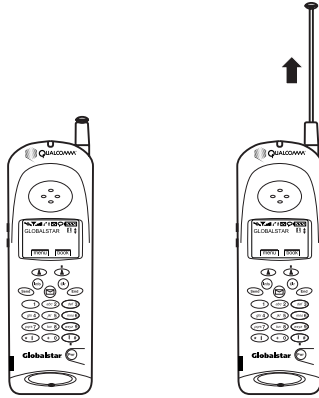

4. Enter the phone number (see Entering numbers, page 14).
5. Press **SEND**.
A message displays if the phone is locked, the phone number is restricted, or there is another problem.

Making data calls

Data calls can be made in both satellite and digital modes. If your satellite service provider offers Globalstar packet data service, data calls are available in the Globalstar mode. Check with your cellular provider for more information on the digital mode.

The QUALCOMM Globalstar packet data kit is required to connect your computer (or Palm™ handheld organizer) to the tri-mode phone. The kit includes a data cable and a CD containing installation software.

With the packet data kit installed, your computer (or Palm™ handheld organizer) can be used to send and receive email, use Telnet or FTP, or browse the Internet. Refer to the QUALCOMM Globalstar packet data kit documentation for specific information on installation, features, and use.

Receiving satellite or cellular calls

To receive a satellite or cellular call

1. Turn the phone on.
2. Rotate the Globalstar antenna or extend the cellular antenna to find service.



Note

To receive satellite calls, the satellite antenna *must* also be rotated to vertical, in a location with a view of the whole sky. Position the phone on its side for better stability.



3. When you receive a call, the phone rings, the indicator light flashes, and the “Incoming Call” message flashes on the screen until the call is answered.
4. To answer a call, do *one* of the following:
 - Press **SEND**.
 - From standby mode, press any key except **Pwr** or **END**. The Any-Key Answer feature must be set to “on.” (See Any-Key Answer, page 64).
5. If you miss a call, a message is displayed. To display the call history list for details about the missed call, press **▲ view**.
6. Press **▲ ok** to return to standby mode.

Ending calls

To end calls, press **END**. The total time of the call briefly displays. (For details of all calls, see Viewing call history details, page 30.)

Displaying your phone number

Your phone has the capacity to host 3 phone numbers (or NAM): 1 for satellite service (which may or may not be a valid cellular phone number depending on your service provider) and 2 cellular only numbers. (Refer to NAM Select, page 76.)

To display these numbers, choose one of the following options:

- From standby mode, press **Info**.
- To display all three possible phone numbers (NAM):
 - Press **▲ menu**.
 - Press **wxyz 9** My Numbers (see My Numbers, page 77).



Note

The currently registered phone number briefly displays when the phone is turned on.

This section provides information on the following functions:

- Phone features and keypad
- Display indicators
- Information key
- Security module
- Antenna

Phone features and keypad

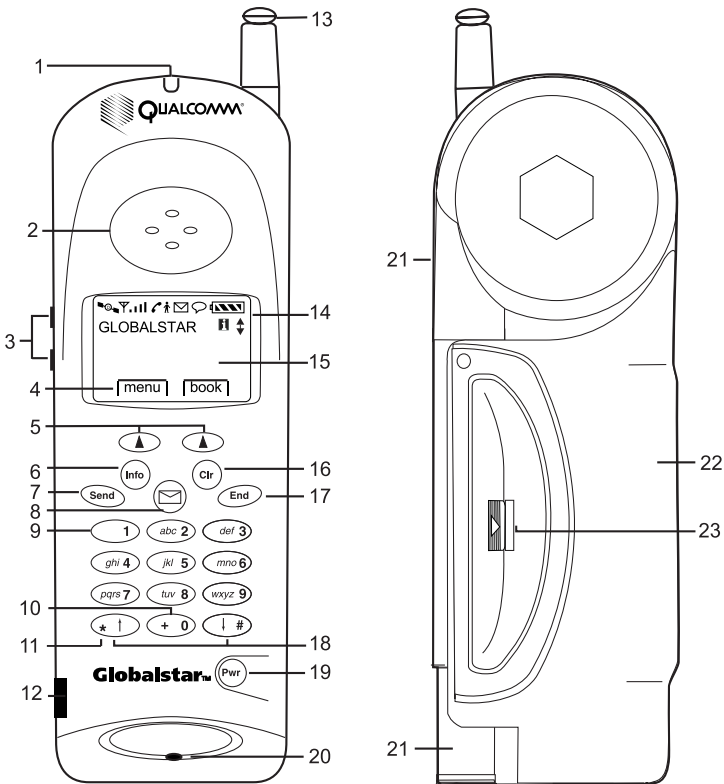

1. Light indicator – Flashes when turning the phone on, when receiving incoming calls, or when receiving text or voice mail messages.
2. Earpiece.

3. Volume buttons
 - Adjust ringer volume when not on a call.
 - Scroll through the menu items if a scroll arrow displays.
 - Scroll through call history and phone book.
 - Move the cursor when editing alphabetic characters or digits.
4. SMART KEY options— Select the SMART KEY option on the screen by pressing the SMART KEY button  below it.
5. SMART KEY buttons.

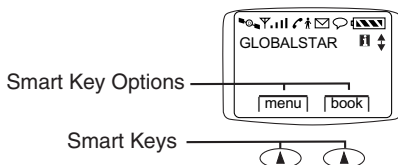



6. Information key – Insert pauses and hyphens.
Additional help is available if **i** displays on the screen. For example, when the phone registers and **i** displays, press  for service provider information and the current phone number.
7. Send key – Originate or answer a call. Also used for features such as call waiting.
8. Message key – Access text messages and voice mail notifications. (See Messages Menu, page 33.)
9. Punctuation key – Add punctuation or spaces when entering letters.
10. International dialing or plus (+) key – Make international calls (see International dialing, page 17).
11. Mode select – In the standby mode, press and hold this key to view and select from the phone modes available (see Manual Mode, page 72).
12. Security module – Required to activate phone for Globalstar satellite service (see Information key, page 10).
13. Cellular antenna.
14. Display indicators – Show phone and battery status (see Display indicators, page 9).
15. Screen.
16. Clear key
 - Delete characters (see Entering numbers, page 14, and Entering letters and other characters, page 21).
 - Return to previous screen.
17. End key – Press to end a call or return to the main menu.
18. Scroll keys
 - Scroll through menu items if a scroll arrow displays on the screen.
 - Move cursor.









19. Power key – Turn the phone on or off.
20. Microphone.
21. Globalstar satellite antenna (see Preparing for satellite calls, page 2).
22. Battery.
23. Battery release latch.

Display indicators

The indicators on the screen show the status of the phone and the battery charge level at a quick glance.





Symbol	Status
	Phone is operating in Globalstar satellite mode.
	Phone is operating in digital mode. If neither  nor  display, the phone is operating in analog mode.
	Indicates signal strength ranging from a strong signal (four lines) to an extremely weak signal (one line).
	Call is in progress.
	No service is available. If service is unavailable, the phone sounds a beep when you try to make a call.
	Roaming – service is established outside the home area.
	Notification of a text message.
	Notification of a Voice mail message.
	Battery charge. Ranges between four diagonal bars (full charge) to one bar (minimal charge) to no bars and blinking (no charge).
	Help available, press  . For example, this symbol displays when the phone is registered and information about the service provider and current phone number is available. (See Information key, page 10)

	Designates an additional level of call privacy (digital).
	Indicates that satellite encryption is turned on (Globalstar).
	Designates the menu option currently selected.
	Indicates that you can scroll between screens using the volume buttons (located on the side of the telephone) or the  and  keys.
	Indicates that either the selected text message is locked or the keypad is locked.
	Indicates that the text message is unlocked.

Information key

The Info (Information) key  has several different functions:

- Provides help if  displays on the screen.
- When the phone registers and  displays on the screen, press  for service provider information and the current phone number.
- Displays your current phone number while on a call.
- Insert pauses and hyphens when entering a phone number.

Security module

The security module activates your phone when in Globalstar satellite mode. It is located on the lower left side of the front of the phone. The security module that comes with your phone works only with that phone and is not interchangeable.



Caution

Do not remove the security module.

When in Globalstar satellite mode, the security module must be properly installed to make or receive calls. If it is not properly installed, you can only make calls to emergency numbers.



Note

If you use the same phone number (or NAM) for both Globalstar satellite and cellular calls, the security module may also have to be installed for non-emergency cellular calls.

For more information, contact your satellite service provider, who installs and maintains the security module.

Antenna

Phone performance depends on the strength of the signal it receives. As you fully extend the cellular antenna or rotate the Globalstar satellite antenna, the signal strength indicator shows the strength of the signal received in that particular antenna position. You cannot make or receive a satellite call with the Globalstar satellite antenna stored.

It is important to use the antennas properly for the best performance. Follow these guidelines for the Globalstar satellite and cellular antennas:

- Never hold the phone by the antenna.
- Do not use the phone if either antenna is damaged, unless you are using the phone with the car kit's antenna.

For more information on how to use the antennas, see *Preparing for satellite calls*, page 2, and *Making cellular calls*, page 4.

This section provides information on the following basic features:

- Turning the phone on and off
- Standby mode
- Power save mode
- Entering numbers
- Making emergency calls
- Redialing a call
- Muting a call
- Possible service provider services

Turning the phone on and off

Turning the phone on

1. Before turning the phone on, make sure that the battery is charged and properly installed (see Battery chargers, page 80, and Battery replacement, page 81).
2. Press and hold  until the indicator light illuminates (about one second).
3. The phone is now in standby mode (see Standby mode, page 14) searching for service.



The message that displays on the screen depends on the service mode selected (see Manual Mode, page 72 or Auto Mode, page 73).



Tip

When the phone is turned on, a Globalstar animation sequence displays. To stop this animation, press any key.

Turning the phone off

1. Press and hold  until “Powering Off” displays.
2. Release .



Tip

If the phone does not turn off, press and hold  for more than one second.

Standby mode

With the power on, the phone is in standby mode while searching for service. The following screens show the search messages that display. (For more information on service modes, see Manual Mode, page 72.)



Once service is established (also called service registered), your banner, the date and time, and the appropriate icons display.



Note

The date and time may not be available in all modes of service.

Power save mode

If service is not established (registered) while in standby mode, it switches to *power save* mode. Power save mode maximizes battery life by periodically looking for service. The following message displays:

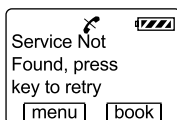

To return to standby mode, press any key.

Entering numbers

When entering a telephone number, the phone accepts up to 32 digits or other characters including hyphens and pauses.



Note

All 32 characters do not always display on certain screens and may be replaced by periods (...). To display the entire number, use the View # option in the Phone Book menu (see Finding entries, page 24) or the Call History menu (see Viewing call history details, page 30).

To enter telephone numbers

From standby mode, use the keypad to enter the desired telephone number directly into the opening screen. After the first number key is pressed, a new screen displays the number and provides the following options.

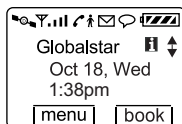

- To save this number in your phone book, press **save**.
- To find this number in your phone book, press **find**.
- To clear this number and start again, press **END**.
- To place the call to this number, press **SEND**.

To edit numbers

1. To move to the number to be edited, press one of the volume buttons located on the side of the phone.
2. When the cursor is flashing over the number to be edited, use the keypad to enter the new digit.



Tip

The **Ctrl** button can also be used to delete a digit.



Note

You cannot use *** ↑** or **↓ #** to move the cursor when entering or editing numbers because these keys are used to enter * or # symbols.

To delete numbers

- Press **Ctrl** to delete one character at a time.
- Press one of the volume buttons to position the cursor over a number, then press **Ctrl** to delete.
- Press and hold **Ctrl** to delete the entire entry.

Making emergency calls

- When using the digital or analog mode, emergency calls are handled in a special way.

When calling the emergency response number in your area (for example, 911), the phone has been programmed to complete the call, then go into a “callback waiting” state. This ensures that the phone is free to receive all incoming calls. The LED continues to flash until you exit from this state. Non-emergency outgoing calls cannot be made at this time.

- When making emergency calls in the Globalstar mode, no special conditions apply.

- Locking or restricting the phone does not prevent making calls to emergency numbers.
- Contact your satellite or cellular service provider for emergency numbers in your area.

To make an emergency call

1. Enter the emergency number (for example, 911).

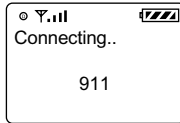

2. Press **SEND**.
3. To exit the emergency callback waiting state (applies to cellular options only), press **END**.
The LED stops flashing. Normal outgoing calls can now resume.

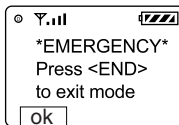

Tip

To clear this alert without leaving Emergency mode, press **Clr** or the **ok** SMART KEY.



Note

While in cellular mode, if you attempt to return to the main menu while still in the Emergency mode, the word "Emergency" (in reverse video) flashes until the **END** button is pushed.

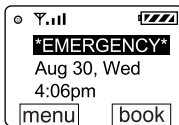

Redialing a call

To redial the last outgoing number

- Press **SEND**.

Muting a call

While on a call, the microphone can be muted so that the caller cannot hear you.

To turn mute on

- Press **▲ mute**. The word “Mute” replaces the word “Time” on the screen until you end the call or turn mute off.



To turn mute off

- Press **▲ mute**. The word “Time” replaces the word “Mute” on the screen.

Possible service provider services

International dialing

To make international calls in Globalstar satellite mode

1. Enter the international access code, the country code, and the phone number.
Shortcut: Press and hold **+ 0** until a plus (+) displays on the screen, and then enter the country code and phone number.
2. Press **SEND**.

If international dialing is supported in your network, contact your satellite service provider for more information.

Position location service in Globalstar mode

While making a call in the Globalstar satellite mode, it is possible to download your current location coordinates. (See Current position coordinates, page 40.)

Call waiting

Call waiting lets you know that you are receiving an incoming call by sounding a beep. For instructions on how to use call waiting, contact your satellite or cellular service provider.

Three-way calling

Three-way calling allows you to talk to two callers at the same time. For instructions on how to use three-way calling, contact your satellite or cellular service provider.

Caller ID

Caller ID displays an incoming call's phone number on the screen, if available. If the phone number of the caller matches one stored in your phone book, the name also displays with the number.

For more information on caller ID, contact your satellite or cellular service provider.

This section provides a guide to

- Accessing the Main Menu
- Navigating and using menus

The following chart shows the various menus available from the main menu. Press  **menu** to access the main menu.

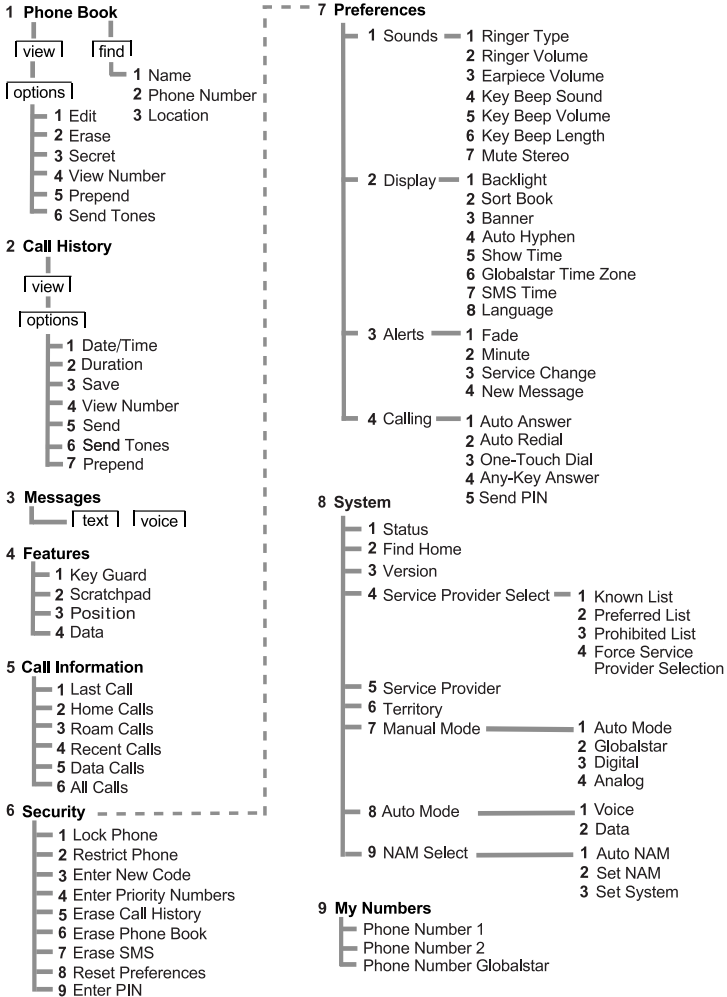

Legend:

- [<word>] = SMART KEY options
- 1 <feature> = menu option

Accessing the Main Menu

The Main Menu contains access to all the phone's features. Use the scroll keys, **(| #)** and **(* |)**, to move between screens. Use **(Ctrl)** to move backward through the screens.

1. To access the Main Menu, turn the phone on. The phone is now in standby mode (see Standby mode, page 14).
2. Press **(▲)** **menu** and the first three Main Menu items display. If scroll arrows display on the screen, scroll between screens to access additional menu options.

Each Main Menu item is explained in sequential order in separate sections of this guide.

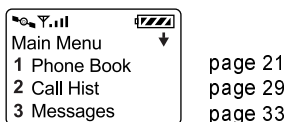

page 21
page 29
page 33

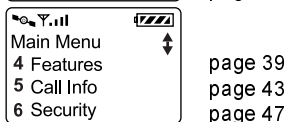

page 39
page 43
page 47

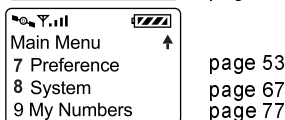

page 53
page 67
page 77

Navigating and using menus

To navigate the menus

- When a scroll arrow (or arrows) displays on the screen, there are additional menu items available. Press a scroll key, **(| #)** or **(* |)**, to access those items.
- To select a menu item, press the corresponding number. For example, to view the menu item **1 Phone Book**, press **(1)**.

To save changes or a setting

- Press **(▲)** **ok**.

To return to previous screen without saving changes

- Press **(Ctrl)**.

To return to standby mode without saving changes (if *not* on a call)

- Press **(END)**.

To return to standby mode without saving changes (if on a call)

- Press **(Ctrl)** repeatedly.

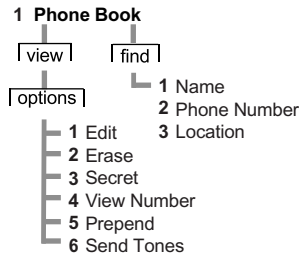

This section provides information on the following functions:

- Entering letters and other characters
- Entering pauses
- Saving entries
- Finding entries
- Editing entries
- Erasing entries
- Using the “secret” feature
- Viewing numbers
- Sending tones
- Prepending numbers
- Speed dialing

Entering letters and other characters

To enter letters and other characters

1. To display a letter in uppercase, then lowercase, and finally the number, press a key repeatedly. For example, if you repeatedly press **(def 3)**, the following characters display:
D E F d e f 3
2. To display the next character on the same key:
 - a. Move the cursor forward one character by pressing **(↓ #)**.
 - b. Press **(def 3)** two (2) times.
The “E” displays. To display the lowercase “e,” press **(def 3)** five (5) times.
3. Complete the text entry using **(↓ #)** to enter a space between words.
4. After all characters are displayed, press **(▲) ok**.

To edit letters and other characters

1. Position the cursor on the character to be edited by choosing one of the following options:
 - Press ***** **↑** or **↓** **#**.
 - Press one of the volume buttons on the side of the phone.
2. From the keypad, enter a new character.

To delete letters and other characters

- To delete one character at a time:
 1. Position the cursor over a character.
 2. Press **(Ctrl)** to delete.
- To delete the entire entry: press and hold **(Ctrl)**.

To enter a space between words

- To enter a space, choose one of the following options:
 - Press **↓** **#**.
 - Press the down volume button on the side of the phone.

To enter punctuation or spaces

- To enter special characters, press **(↑)** repeatedly.
- The punctuation or space displays in the following order: – <space> @ & () : . ‘ # * , 1.



Tip

To move backward between screens, press **(Ctrl)**.

Entering pauses

When using automated phone services, such as voice mail or online banking, adding a “pause” when entering a series of numbers allows a segment of time to be included in the string of characters. Each pause counts as one character. This pause allows one remote electronic process to complete before another starts.

Pauses can be entered manually or saved in a phone book entry. There are two types of pauses:

- **Hard Pause** – Stops until you press **(▲)** **resume** to send the rest of the number sequence.
- **Timed Pause** – Stops for two seconds and then resumes automatically.





Note

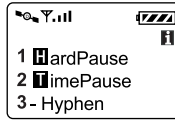

If Auto Hyphen is set to “on” and you manually enter pauses, Auto Hyphen is temporarily set to “off.” (See Auto Hyphens, page 58 and Manual Hyphens, page 58.)

To enter pauses when entering numbers

- To enter a pause, press .



- Press  Hard Pause or  Timed Pause.

A symbol displays on the screen for a hard pause  or a timed pause .

- Continue entering numbers.

Saving entries





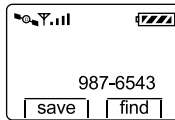

The phone saves up to 99 entries. Each entry contains a name (up to 12 characters) and phone number (up to 32 numbers) stored in location numbers 1 through 99. (See Entering numbers, page 14.)

To save a name and phone number

- Enter a phone number using one of the following options:

- From standby mode:
 - Enter a phone number.
 - Press  **save**.



- From the call history list (see Call History Menu, page 29):
 - Select a number.
 - Press  **view**.
 - Press  **options**.
 - Press  **save**.
 - From the scratchpad (see Scratchpad, page 39):
 - Enter a number.
 - Press  **options**.
 - Press  **save**.
 - From the screen:
 - Select a number on the screen, such as Caller ID.
 - Press  **save**.
- Using the keypad, enter a name.
 - Press  **ok**.

4. Select a location number.
 - If the phone book is not full, you are asked to accept an empty location. Choose one of the following options:
 - Accept the empty location, press **▲** **ok**.
 - Enter a location number of your choice, press **▲** **ok**.
 - Scroll to select an empty location, press **▲** **ok**.
 - If the phone book is full, enter a location number that you want to reuse and replace with the new information. The old information is deleted.

Finding entries

Find entries by name, phone number, or location number. Quickly advance to groups of ten entries, or scroll through each entry one at a time.

To find an entry

1. From standby mode, press **▲** **book**.
2. Choose one of the following options:
 - Scroll through each entry one at a time.
 - Advance to groups of ten entries by entering 1 through 9. (For example, enter 6; location number 60 is selected. If 60 is empty, the previous filled location is selected.)
 - Locate specific entries using the **find** function:
 - Press **▲** **find**.
 - Choose one of the following options:
 - Name, press **1**.
 - Phone #, press **abc2**.
 - Location, press **def 3**.
 - Enter one or more characters (all characters are classified by the search function as lowercase).
 - Press **▲** **find**.
3. Select an entry.
4. To view an entry, press **▲** **view**.
5. To call the number, press **SEND**.
6. To edit, erase, make secret, view number, prepend (add), or send tones, press **▲** **options**.

Editing entries

Changes can be made to an entry name, phone number, or location.

To edit an entry

1. From standby mode, press **▲** **book**.
2. Scroll to the entry to be changed.

3. Press **▲** **view**.
4. Press **▲** **options**.
5. To edit, press **1**. Select one of the following categories:
 - Name
 - Press **1**.
 - Enter changes.
 - Press **▲** **ok**.
 - Phone #
 - Press **abc 2**.
 - Enter changes.
 - Press **▲** **ok**.
 - Location
 - Press **def 3**.
 - Select one of the following options:
 - Use the same location number, press **▲** **ok**.
 - Enter a location number of your choice, press **▲** **ok**.
 - Scroll to select an empty location, press **▲** **ok**.

Erasing entries

Entries can be erased quickly and easily with a few keystrokes.

To erase an entry

1. From standby mode, press **▲** **book**.
2. Scroll to the entry to be erased.
3. Press **▲** **view**.
4. Press **▲** **options**.
5. Press **abc 2** to erase.
6. Press **▲** **ok**.

Using the “secret” feature

To prevent a phone number from displaying on the screen, use the secret function. To view or change a secret entry, use the lock code. (See Lock code, page 47.)







Note



When receiving an incoming call, caller ID prevents the name from displaying if the entry in the phone book is secret.

To configure the secret function

1. From standby mode, press **▲** **book**.
2. Scroll to the entry to be changed.

3. Press  **view**.
4. Press  **options**.
5. Press  .
6. Select *one* of the following options:
 - Yes – Make the entry secret
 - No – Make the entry nonsecret
7. Press  **ok**.







To view or change a secret entry

1. From standby mode, press  **book**.
2. Scroll to the secret entry.
3. Enter your lock code.
4. Press  **ok** to accept any changes.

Viewing numbers

An entry's entire phone number can be viewed. When viewing a number, you can also prepend (add) numbers at the beginning of a phone number and save those changes.

To view a number

1. From standby mode, press  **book**.
2. Scroll to the entry to be viewed.
3. Press  **view**.
4. Press  **options**.
5. Press  View #.
6. Select one of the following options:
 - To return to the previous menu, press  **ok**.
 - To return to standby mode, press .

Sending tones

While making a call you may need to send DTMF (dual tone multifrequency) tones over the air. Automated phone services, such as voice mail or online banking usually require a tone before activating.

Tones are sent by manually entering numbers, or using numbers stored in the phone book. You can also send tones for numbers entered in the scratchpad (see Scratchpad, page 39).







Note

The length of the key beep, the sound you hear when pressing the keys, affects the DTMF tones in analog mode. Check your key beep length before sending tones (see Key Beep Length, page 55).

To send tones manually

- While on a call, enter the appropriate numbers.
- The tones associated with the numbers are immediately sent over the air.





To send tones saved in the phone book

1. While on a call, press  **book**.
2. Scroll to an entry.
3. Press  **view**.
4. Press  **options**.
5. Press  Send Tones. The tones associated with the numbers are immediately sent over the air.

Prepending numbers

Add (prepend) numbers, such as an area code or country code, at the beginning of a phone number in an existing phone book entry.

To prepend (add) numbers

1. From standby mode, press  **book**.
2. Scroll to the entry to be changed.
3. Press  **view**.
4. Press  **options**.
5. Press  Prepend.
The phone number displays.
6. Enter the numbers to be added to the displayed characters.
7. Press  **save**.

Speed dialing

Speed dial a phone number if you know the location number of the phone book entry. Speed dial any of the 99 location numbers unless the phone is restricted. If you restrict the phone, only the first nine phone book locations are available for speed dial. (See Restricting the phone, page 48.)

To speed dial a phone number

1. Enter the location number.
2. Press .

One-touch dialing

If one-touch dial is set to “on,” dial any of the 99 location numbers without pressing .

To one-touch dial a location number

1. Set one-touch dial to “on” (see One-Touch Dial, page 64).
2. Press and hold the location number.



Tip

For double-digit locations, press and release the first digit, and then press and hold the second digit. For example:

- ❑ To enter location number 3, press and hold **(def 3)**.
- ❑ To enter location number 32, press **(def 3)**, then press and hold **(abc 2)**.

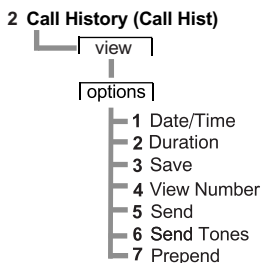

This section provides information on how to use the call history list:

- Accessing the call history list
- Viewing call history details

The call history list contains the last ten incoming or outgoing satellite or cellular calls and includes the following details on each call:

Called by	Incoming calls, if caller ID is available (see Caller ID, page 18)
Call to	Outgoing calls
Added	Scratchpad entries (see Scratchpad, page 39)
Missed	Unanswered incoming calls, if caller ID is available
Caller ID	Caller ID information received
Call Waiting	Call-waiting information received during a call

- The most recent call is numbered 0 and displays at the top of the list and the oldest call displays at the bottom (separated by a dashed line).
- When the list is full, a new call takes the first position in the list and the oldest call is deleted.
- The list is saved after you turn the phone off.
- If the caller's phone number is stored in the phone book, the caller's name displays in the call history list.
- If more than one name matches a call back number, the entry with the lowest phone book location number displays.

Accessing the call history list

To access the call history list

1. From standby mode, press **▲** **menu**.
2. Press **abc2** Call History.
3. To access the last ten calls, press the scroll keys. For example:

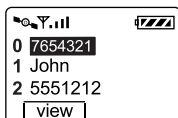

4. Scroll *down* to select a call from the most recent to the oldest calls, or scroll *up* to select a call from the oldest to the most recent.
5. After selecting a call, choose one of the following options:
 - To call the number, press **SEND**.
 - To save the number in your phone book:
 - Press **▲** **view**.
 - Press **▲** **save**.
 - Press **▲** **ok** (see Saving entries, page 23).
 - To exit call history without calling or storing a number, press **Clr** or **END**.

Viewing call history details

To view call history details

1. Scroll to select a call on the list.

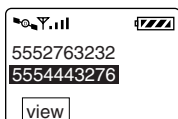

2. Press **▲** **view**.

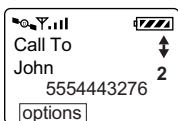

3. Press **▲** **options**.

4. Select *one* of the following:

- Date/Time – Display the date and time of the call.

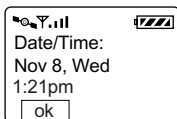

- Duration – Display the duration of the call.

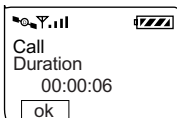

- Save – Save the number in your phone book.

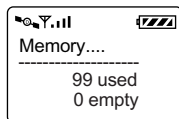
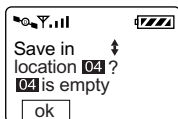
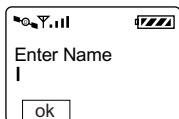

- View # – View the entire number.
- Send – Make a call to the number.
- Send Tones – Send DTMF tones while on a call. (See Sending tones, page 26.)
- Prepend – Add numbers, such as an area code or country code, at the beginning of the phone number and save it in the phone book.

3 Messages

| text | | voice |

This section provides information about SMS (short message service) text and voice mail messages.

- Message alerts
- Reading Messages
- Voice messages
- Text messages

Contact your satellite or cellular service providers for information regarding the availability of text and voice mail notifications.

Message alerts

The phone can be configured for message alerts (see *New Message*, page 62). When the phone is turned on and a SMS message is received, the phone alerts you by:

- Flashing the indicator light
- Sounding a beep
- Displaying the text message indicator or voice mail notification indicator  on the screen.

The text message and voice mail notification indicators display until all messages are read.

Reading Messages

When reading messages, new messages are accessed first. If the message contains a call back number matching one in your phone book, the corresponding name displays in place of the number. If more than one name matches a call back number, the entry with the lowest phone book location number displays.

Voice messages

Accessing voice mail messages

If someone leaves a voice mail message, your phone receives a voice mail notification and alerts you. To access messages choose one of the following options:

- Access voice mail notifications for call details.
- Call your voice mail system to listen to the message. (Service providers vary on the details provided about the message.)

If you have more than one voice mail system, the total number of voice mail messages received by all systems displays on the screen.

For example, if you have two voice mail systems and receive two voice mail messages from one system and two from the other system, the total number of voice mail notifications displayed under “Old” is 4.

Msgs	New/Old
Text	00/00
Voice	04
text	voice

If new voice mail messages are received, the total number of voice mail notifications is updated.

To access voice mail notifications

1. From standby mode, press .
The total number of voice mail messages received displays under “Old.”
2. Press **voice**.
The voice mail notification displays either a call back number or a name if the call back number matches one in the phone book.



Note

If more than one name matches a call back number, the entry with the lowest phone book location number displays.

3. Select a message, then choose one of the following options:
 - To display more detail, if available, press **view**.
The detail information automatically scrolls on the screen and pauses so you can read it.
 - To manually scroll, press a scroll key.
 - To read the next voice mail notification, press **next**.

To call your voice mail system

1. Press .
2. Press **voice**.
3. To find the voice mail notification you want, press **next**.
4. Press **view**.
5. Press .
The phone number for the voice mail system displays, if available.
If it does not display, the message “No Voice Mail Number received” displays. Manually enter the voice mail phone number.
6. If necessary, prepend (add) digits before the voice mail phone number.
For example, if you are out of the area of your voice mail phone number, prepend the area code or country code.
7. Press again.
8. To retrieve your messages follow the voice mail system instructions.

To erase voice message notifications

1. Press .
2. Press  **voice**.
3. To find the voice mail notification you want, press  **next**.
4. Press  **view**.
5. To erase the message, press  **erase**.
6. Press  **ok**.

Text messages



Text messages can include call back numbers, messages, urgency stamps, time and date stamps, and names if the call back number matches one in the phone book. The phone stores as many text messages as available memory allows. For more information on managing phone memory, see Storing text messages, page 36.

Accessing text messages





To access text messages

1. Press .

The number of new and old text messages displays.
2. Press  **text**.





The newest unread messages display first followed by the newest read messages, if any. The number of messages under “Old” is the number of messages already read but not deleted.
3. Select a message then choose one of the following:
 - To display more detail, if available, press  **view**.
The text automatically scrolls on the screen and pauses so you can read it.
 - To manually scroll, press a scroll key.
 - To read the next message, press  **next**.

To call back numbers in text messages

1. Press .
2. Press  **text**.
3. To find the message you want, press  **next**.
4. Press  **view**.
5. Press .

The call back number displays, if available.
6. If necessary, prepend (add) digits before the call back number.
For example, if you are out of the area of the phone number, prepend the area code or country code.
7. Press  again.

To erase text messages

1. Press .
2. Press  **text**. A text message displays.
3. To display more detail, if available, press  **view**.
The text automatically scrolls on the screen and pauses so that you can read it.
4. To manually scroll, press a scroll key.
5. Scroll to the bottom of the message, press  **options**.
6. For Erase, press .



Tip

You can erase a text message even if it is locked.

7. To erase the message, press  **ok**.

Storing text messages

Text messages are automatically saved until you erase them or until the phone memory is full. To keep enough memory available, delete each message.

- If more than 75% of the phone's memory is full, a message displays the amount of memory used:

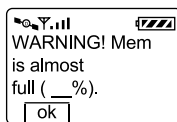

- To exit from this screen, press  **ok**.

When the phone is out of memory, the oldest unlocked messages are automatically deleted as necessary to receive new messages.



Tip

Lock messages to prevent them from being deleted. However, if all messages are locked when a new message is received and the phone is out of memory, the new message is lost. The network may try to deliver it later.

To avoid running out of memory

- Erase locked or unlocked messages that you no longer need. When the phone is out of memory and all text messages are locked, it no longer accepts new messages and this message displays:

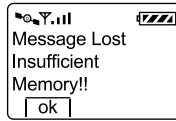

- To exit from this screen, press **ok**.



Note

The network may try to deliver lost messages later.

Locking and unlocking text messages

The Lock feature prevents messages from being automatically deleted if the phone is out of memory. Text messages can be manually erased even if locked.

To lock or unlock text messages

1. Press .
2. Press **text**.
The newest text message displays.
3. To display more detail, if available, press **view**.
The text automatically scrolls on the screen and pauses so that you can read it.
4. To manually scroll, press a scroll key.
5. Scroll to the bottom of the message and press **options**.
6. Press Lock or Unlock.
The lock indicator or the unlock indicator displays to the left of the SMART KEY options.

Features Menu

4 Features

- 1 Key Guard
- 2 Scratchpad
- 3 Position
- 4 Data

This section provides information on how to use the following features:

- Key Guard
- Scratchpad
- Current position coordinates
- Data speed

Key Guard

The key guard locks the phone keys to prevent accidental use. If you receive an incoming call when the key guard is on, answer the call by pressing



 .



Note

The key beeps are silenced when the keyguard is set to “on.”

To turn the key guard on

- *Shortcut:* From standby mode, press and hold  . The lock indicator  and “KeyGuard On” displays.

To turn the key guard off

- Press    .



Note

Lock your phone to prevent unauthorized use. (See Locking the phone, page 48.)

Scratchpad

This feature provides a shortcut to storing information. Enter numbers on the scratchpad to

- Add to call history
- Save to the phone book
- Send tones over the air for automated phone services, such as voice mail or banking online



Note

To add to call history or save to the phone book, you can be on a call or in standby mode. To send tones, you must be on a call.

To access the scratchpad

1. From standby mode, press **▲** **menu**.
2. Press **ghi 4** Features.
3. Press **abc 2** Scratchpad.
4. Enter numbers.
5. Press **▲** **options**.
6. Choose one of the following options:
 - AddToHist, press **1**; the number is added to call history.
 - Save to the phone book, press **abc 2** (see Saving entries, page 23).
 - Send Tones, press **def 3**; the tones are immediately sent over the air.

Current position coordinates

This feature allows your current position coordinates to be downloaded to the phone. This information is only available while a Globalstar satellite call is in progress.

To receive current position coordinates while making a call

1. Press **▲** **menu**.
2. Press **ghi 4** Features.
3. Press **def 3** Position.



Note





Before the update button is pressed, the coordinates that appear show the last known position. This information can be accessed in any calling mode. The current position is available only in satellite mode.

4. Press **▲** **Update**.

Data speed

This feature allows you to set the baud rate before making data calls. The baud rate is the speed at which the phone communicates the data to or from the attached terminal equipment (for example, your computer or Palm™ handheld organizer).

To set the baud rate:

1. From standby mode, press  **menu**.
2. Press  **Features**
3. Press  **Data**.
4. Scroll to select a baud rate: 9600, 19200, 38400, 57600, or 115200.
5. Press  **ok**.

See the QUALCOMM Globalstar packet data kit documentation that comes with your data cable for more information on making data calls.

Call Information Menu

5 Call Information (Call Info)

- 1 Last Call
- 2 Home Calls
- 3 Roam Calls
- 4 Recent Calls
- 5 Data Calls
- 6 All Calls

This section provides information on how to set counters that track the number of calls and airtime for billing purposes:

- Last Call
- Home Calls
- Roam Calls
- Recent Calls
- Data Calls
- All Calls
- Resetting call counters

Last Call

Last Call displays the duration of the last call in minutes and seconds. If Call History is empty, "None" displays on the screen.

To display last call information

1. From standby mode, press **▲** **menu**.
2. Press **(jkl) 5** Call Information.
3. Press **(1)** Last Call.
4. Press **▲** **ok**.

Home Calls

Home Calls displays the number and duration of all incoming and outgoing calls made in your home service area. (To reset this counter to zero, see Resetting call counters, page 45).





To display home calls information

1. From standby mode, press **▲** **menu**.
2. Press **(jkl) 5** Call Information.
3. Press **(abc) 2** Home Calls.
4. Press **▲** **ok**.

Roam Calls

Roam Calls displays the number and duration of calls made while roaming out of your home service area. (To reset this counter to zero, see Resetting call counters, page 45).





To display Roam Calls information

1. From standby mode, press  **menu**.
2. Press  Call Information.
3. Press  Roam Calls.
4. Press  **ok**.

Recent Calls

Recent Calls displays the number and duration of calls made or received since resetting the counter. (To reset this counter to zero, see Resetting call counters, page 45).





To display Recent Calls information

1. From standby mode, press  **menu**.
2. Press  Call Information.
3. Press  Recent Calls.
4. Press  **ok**.

Data Calls

Data Calls displays the number of bytes received or transmitted and the duration of data calls made since resetting the counter. (To reset this counter to zero, see Resetting call counters, page 45)

To display Data Calls information





1. From standby mode, press  **menu**.
2. Press  Call Information.
3. Press  Data Calls.
4. Scroll to view the number of bytes received or transmitted and the duration of each call.
5. Press  **ok**.

See the QUALCOMM Globalstar packet data kit documentation that comes with your data cable for more information on making data calls.

All Calls

All Calls displays the number and duration of all calls (both voice and data) for the lifetime of your phone. You cannot reset this counter.



To display All Calls information

1. From standby mode, press  **menu**.
2. Press  Call Information.
3. Press  All Calls.
4. Press  **ok**.

Resetting call counters

All counters can be reset to zero except Last Call and All Calls. If you want to undo the counter reset, you must do it before you press  **ok**, which confirms resetting the counter.

To reset the counter to zero

1. From standby mode, press  **menu**.
2. Press  Call Information.
3. Select a call counter.
4. Press  **zero**.



Note

After you press  **ok**, you cannot undo the counter reset.

5. Press  **ok**.

To undo the counter reset

- Press  **undo**.

6 Security

- 1 Lock Phone
- 2 Restrict Phone
- 3 Enter New Code
- 4 Enter Priority Numbers
- 5 Erase Call History
- 6 Erase Phone Book
- 7 Erase SMS
- 8 Reset Preferences
- 9 Enter PIN

This section provides information on how to use the following security features:

- Lock code
- Locking the phone
- Restricting the phone
- Entering priority numbers
- Erasing call history list
- Erasing phone book entries
- Erasing SMS messages
- Resetting preferences
- Entering PIN





Lock code

When accessing the Security menu for the first time, enter the lock code supplied by your satellite or cellular service provider. If you forget the lock code, contact your satellite or cellular service provider.

Entering a new lock code

If it becomes necessary to change the lock code, create a new 4-digit code.

To enter the new lock code

1. From standby mode, press  menu.
2. Press  Security.
3. Enter the current lock code.
4. Press  New Code.
5. Enter your new 4-digit lock code.
6. Press  save.

The phone displays confirmation of the new code entry.

Locking the phone

The phone can be locked to prohibit any outgoing calls except priority and emergency numbers.

- Incoming calls are not affected.
- No shortcuts are available for dialing emergency or priority numbers.
- All other functions are locked.



Tip

To unlock the phone, enter the same lock code used to access the Security menu.

To lock the phone

1. From standby mode, press **▲** menu.
2. Press **mno6** Security.
3. Enter your lock code.
4. Press **1** Lock Phone.
5. Scroll to select *one* of these options:
 - Never – The phone cannot be locked.
 - Now – Immediately locks the phone for one time only.
 - On Power Up – Locks the phone every time you turn the phone on.

To unlock the phone

1. Press **▲** unlock.
2. To return to the main menu, enter your lock code. (Enter the same lock code used to access the Security menu.)

Restricting the phone

Restricting the phone limits outgoing calls to emergency and priority numbers, plus phone book locations 1 to 9. Phone book changes cannot be made in this mode.

To restrict the phone

1. From standby mode, press **▲** menu.
2. Press **mno6** Security.
3. Enter your lock code.
4. Press **abc2** Restricted.
5. Scroll to select *one* of these options:
 - Yes – Make calls to emergency numbers, priority numbers, and phone book locations 1 to 9 only.
There are no shortcuts for dialing emergency numbers or priority numbers unless you add them to your phone book.
 - No – Make calls to any number.

Entering priority numbers

Priority numbers can be called when the phone is locked or restricted. Store up to three priority numbers (maximum 32 digits each).

To enter a priority number

1. From standby mode, press **▲** **menu**.
2. Press **mno6** Security.
3. Enter your lock code.
4. Press **ghi4** Priority #.
5. Scroll to Priority#1, Priority#2, or Priority#3.
6. Press **▲** **edit**.
7. Enter the phone number.
8. Press **▲** **ok**.

Erasing call history list

This feature erases the entire call history list.

To erase the entire call history list

1. From standby mode, press **▲** **menu**.
2. Press **mno6** Security.
3. Enter your lock code.
4. Press **ijkl5** Erase Call.
5. Press **▲** **ok**.
6. To erase the entire call history list, press **▲** **ok**.
7. To return to the menu without erasing the list, press **END**.

Erasing phone book entries

This feature erases all entries in the phone book.

To erase all entries in the phone book

1. From standby mode, press **▲** **menu**.
2. Press **mno6** Security.
3. Enter your lock code.
4. Press **mno6** Erase Book.
5. Press **▲** **ok**.
6. To erase all entries in the phone book, press **▲** **ok**.
7. To return to the menu without erasing the entries, press **END**.

Erasing SMS messages

This feature erases all SMS (short message service) messages, including all locked or unlocked text messages and all voice mail notification messages. Use this erase feature to avoid running out of memory (see To avoid running out of memory, page 37).

1. From standby mode, press **▲** **menu**.
2. Press **mno 6** Security.
3. Enter your lock code.
4. Press **pqrs 7** Erase SMS (short message service).
5. Press **▲** **ok**.
6. To erase all messages, press **▲** **ok**.
7. To return to the menu without erasing any messages, press **END**.

Resetting preferences

This feature resets all preferences to the original settings (defaults) entered by your satellite or cellular service provider. These preferences include those described in Preferences Menu, page 53, with these exceptions:

- The banner is *not* reset.
- The Service Provider Preferred and Prohibited Lists *are* deleted (see Service Provider Select, page 69).
- The lock code is *not* reset.
- The phone book, call history, or SMS messages are *not* erased.

To reset preferences

1. From standby mode, press **▲** **menu**.
2. Press **mno 6** Security, enter your lock code.
3. Press **tuv 8** Reset Prefs.
4. Press **▲** **ok**.
5. When prompted to reset all preferences, press **▲** **ok**.

Entering PIN





When making analog calls, your cellular service provider may support the use of your own PIN (personal identification number) for verification before connecting your call.

- To be prompted for your PIN before making analog calls, set Send PIN accordingly (see Send PIN, page 65). Contact your cellular service provider for more information.
- Each PIN is associated with a different phone number, or NAM (number assignment module).

**Caution**

When you enter a PIN, it becomes associated with the currently selected phone number, so be sure to select the appropriate phone number before entering your PIN.

To enter your PIN

1. Select the appropriate phone number (NAM). (See NAM Select, page 76).
2. From standby mode, press  **menu**.
3. Press  **Security**.
4. Enter your lock code.
5. Press  **Enter PIN**.
6. Enter the four-digit PIN.
7. Press  **save**.

Preferences Menu

7 Preferences	
1 Sounds	1 Ringer Type 2 Ringer Volume 3 Earpiece Volume 4 Key Beep Sound 5 Key Beep Volume 6 Key Beep Length 7 Mute Stereo
2 Display	1 Backlight 2 Sort Book 3 Banner 4 Auto Hyphen 5 Show Time 6 Globalstar Time Zone 7 SMS Time 8 Language
3 Alerts	1 Fade 2 Minute 3 Service Change 4 New Message
4 Calling	1 Auto Answer 2 Auto Redial 3 One-Touch Dial 4 Any-Key Answer 5 Send PIN

This section provides information on how to set the following phone preferences:

- Sounds
- Display
- SMS Time
- Language
- Alerts
- Calling

Sounds

To set up your personal sound preferences, changes can be made to the following functions:

- Ringer type
- Ringer volume
- Earpiece volume
- Key beep sound
- Key beep volume
- Key beep length
- Mute stereo

Ringer Type

For incoming calls, the ringer can be changed to one of eight different rings or melodies.

To set the incoming call's ringer type

1. From standby mode, press **▲** **menu**.
2. Press **(pqrs 7)** Preferences.
3. Press **(1)** Sounds.
4. Press **(1)** Ringer Type.
5. Press **(* 1)** or **(1 #)** to select a ringer type or melody from the list.
6. Press **▲** **ok**.

Ringer Volume

The ringer volume can be increased, decreased, or turned off.

To set the ringer volume

From standby mode, to change the ringer volume choose *one* of the following:

- Press the volume buttons on the side of the phone.
- Press **▲** **menu**.
 - Press **(pqrs 7)** Preferences.
 - Press **(1)** Sounds.
 - Press **(abc 2)** Ringer Vol.
 - Press **(* 1)** to increase or **(1 #)** to decrease the volume.
 - To turn the ringer off, press **(1 #)** until the word "Silent" appears.
 - To remind you that the ringer is off, "-Ringer Off-" flashes in standby mode.
 - Press **▲** **ok**.



Tip

While on a call, adjust the volume by pressing the buttons on the side of the phone.

To silence the ringer when receiving a call

- Press **(END)**.

Earpiece Volume

The earpiece volume is adjustable while on a call or from standby mode. When using the car kit, this feature adjusts the speaker volume or the privacy handset volume.

To adjust the earpiece volume while on a call

- Press the volume buttons on the side of the phone.

To adjust the earpiece volume while in standby mode

1. Press **▲** menu.
2. Press **(pqrs 7)** Preferences.
3. Press **(1)** Sounds.
4. Press **(def 3)** EarpiecVol.
5. Press **(* |)** to increase or **(| #)** to decrease the volume.
6. Press **▲** ok.

Key Beep Sound

The sound you hear when pressing the keys (key beep) can be adjusted to either a tone or a click.

To adjust the key beep sound

1. From standby mode, press **▲** menu.
2. Press **(pqrs 7)** Preferences.
3. Press **(1)** Sounds.
4. Press **(ghi 4)** KeyBeepSound.
5. Press **(* |)** or **(| #)** to select “tone.” A tone sounds.
6. Press **(* |)** or **(| #)** again to select “click.” A click sounds.



Note

While on a call, if you select “click”, keys pressed for voice mail sound as “tones.” Other keys pressed in menus sound as “clicks.”

7. Press **▲** ok.

Key Beep Volume

The volume of the sound you hear when pressing the keys (key beep), can be adjusted.

To adjust the key beep volume

1. From standby mode, press **▲** menu.
2. Press **(pqrs 7)** Preferences.
3. Press **(1)** Sounds.
4. Press **(jkl 5)** KeyBeepVol.
5. Press **(* |)** to increase or **(| #)** to decrease the volume.
6. To turn the key beep volume off, press **(| #)** until the word “Silent” appears.
7. Press **▲** ok.

Key Beep Length

The length of the sound you hear when pressing the keys (key beep) can be changed. The standard key beep is short and fixed in length. The custom key beep sounds as long as you press a key.

Using the standard key beep setting is recommended unless a service or device, such as an answering machine, requires a custom key beep.



Note

In analog mode, the key beep length affects the DTMF tones used for sending tones over the network for automated phone services, such as voice mail or online banking. Select the appropriate key beep length before sending tones (see Sending tones, page 26).

To set the key beep length

1. From standby mode, press **▲** **menu**.
2. Press **(pqrs 7)** Preferences.
3. Press **(1)** Sounds.
4. Press **(mno 6)** KeyBeepLen.
5. Press **(* 1)** or **(1 #)** to select “yes.” Press again to select “no.”
 - Standard – Key beep is short and fixed in length.
 - Custom – Key beep sounds as long as you press a key.
6. Press **▲** **ok**.

Mute Stereo

To use this feature the car kit mute line must be connected to the stereo mute line. When using the car kit, this feature can be set to automatically mute the stereo in your vehicle when receiving incoming calls. Press **(SEND)** when making outgoing calls. (Contact your service provider or car kit installer for more information on implementing this in your vehicle.)

To mute the stereo

1. Be sure that the car kit mute line is connected to the stereo mute line.
2. From standby mode, press **▲** **menu**.
3. Press **(pqrs 7)** Preferences.
4. Press **(1)** Sounds.
5. Press **(pqrs 7)** Mute Stereo.
6. Press **(* 1)** or **(1 #)** to select “yes.” Press again to select “no.”
7. Press **▲** **ok**.

Display





The following display features can be adjusted:

- Backlight
- Banner
- Time
- Auto hyphen feature
- Globalstar time zone

Backlight

The screen and keypad backlighting can be adjusted to maximize battery life.

To set the backlight

1. From standby mode, press  **menu**.
2. Press  Preferences.
3. Press  Display.
4. Press  Backlight.
5. Scroll to select one of the following:
 - Always Off – The backlight is always off, which significantly *increases* battery life.
 - 7 Seconds – Turns the backlight off 7 seconds after the last key press.
 - 15 Seconds – Turns the backlight off 15 seconds after the last key press.
 - 30 Seconds – Turns the backlight off 30 seconds after the last key press.
 - Always On – The backlight is always on, which significantly *decreases* battery life.
6. Press  **ok**.

To turn the backlight on

- Press any key.









Note

If this feature is set to “Always Off,” pressing any key does *not* turn the backlight on.

Sort Book

This option allows users to select whether the phone book displays in numerical location order or by alphabetic name order.







To set the sort order

1. From standby mode, press  **menu**.
2. Press  Preferences.
3. Press  Display.
4. Press  Sort Book.
5. Press  or  to select “location.” Press again to select “alphabetic.”
6. Press  **ok** to confirm sort change.

Banner

When the phone is turned on, a banner or personal greeting can be displayed. As many as 12 characters can be added to the startup screen, such as a company name or a personal reminder.

To edit the banner

1. From standby mode, press  **menu**.
2. Press  Preferences.
3. Press  Display.
4. Press  Banner.
5. Choose one of the following:
 - Press  **ok** to return to standby mode.
 - Press  **edit** to change the banner. (See Entering numbers, page 14.)
6. Press  **ok** to confirm banner changes.

Auto Hyphens

This feature automatically inserts hyphens when entering phone numbers. As the following example shows, hyphens are inserted automatically when numbers are entered:









- ### - ### -



Note

To manually enter hyphens, see Manual Hyphens, page 58.

To set auto hyphen

1. From standby mode, press  **menu**.
2. Press  Preferences.
3. Press  Display.
4. Press  AutoHyphen.
5. Press   or   to select “yes.” Press again to select “no.”
6. Press  **ok**.

Manual Hyphens

Hyphens can be entered manually from standby mode or when editing numbers in the phone book. Each hyphen counts as one character.



Note

To automatically insert hyphens, see Auto Hyphens, page 58.

To manually enter a hyphen

1. Press **(info)**. The following screen displays:

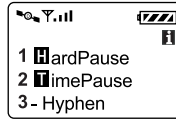

2. To display a hyphen on the screen, press **(def 3)**.

Show Time

The time format can be set by selecting 12-hour, 24-hour, UTC or Off. In Globalstar satellite mode, UTC (universal coordinated time) displays as the default mode. While in digital or analog cellular mode, local time displays where available.

To set the time format

1. From standby mode, press **(▲)** **menu**.
2. Press **(pqrs 7)** Preferences.
3. Press **(abc 2)** Display.
4. Press **(jkl 5)** Show Time.
5. Press **(* 1)** or **(↓ #)** to select one of the following:
 - 12 hour – Time displays in 12-hour format
 - 24 hour – Time displays in 24-hour format
 - UTC (universal coordinated time) – 24-hour time scale maintained by the Bureau International de L'Heure
 - Off – Time does not display
6. Press **(▲)** **ok**.

Globalstar Time Zone

When in Globalstar satellite mode this feature allows you to select the display of a different time zone instead of UTC (universal coordinated time) time. The time zone remains selected until you change it and is only valid in the Globalstar satellite mode. UTC (plus or minus any hour) is an option if your time zone is unavailable.

The time zones for selection include the following:

European	GMT	Greenwich Mean Time	same as UTC
	BST	British Summer Time	UTC + 1 hour
	IST	Irish Summer Time	UTC + 1 hour
	WET	Western Europe Time	same as UTC
	WEST	Western Europe Summer Time	UTC + 1 hour
	CET	Central Europe Time	UTC + 1 hour

	CEST	Central Europe Summer Time	UTC + 2 hours
	EET	Eastern Europe Time	UTC + 2 hours
	EEST	Eastern Europe Summer Time	UTC + 3 hours
	MSK	Moscow Time	UTC + 3 hours
	MSD	Moscow Summer Time	UTC + 4 hours
	MSD	Moscow Summer, Irkutsk	MSD + 5 hours
	MSK	Moscow, Chita, Yakutsk	MSK + 6 hours
	MSD	Moscow Summer, Chita, Yakutsk	MSK + 6 hours
	MSK	Moscow, Vladivostock, Khabavorsk, Sakhalin	MSK + 7 hours
	MSK	Moscow, Magadan	MSK + 8 hours
	MSD	Moscow Summer, Magadan	MSD + 8 hours
	MSK	Moscow, Kamchatka, Anadyr	MSK + 9 hours
	MSD	Moscow Summer, Kamchatka, Anadyr	MSD + 9 hours
	Beij	Beijing, China	UTC + 8 hours
U.S. and Canada	AST	Atlantic Standard Time	UTC - 4 hours
	ADT	Atlantic Daylight Saving Time	UTC - 3 hours
	EST	Eastern Standard Time	UTC - 5 hours
	EDT	Eastern Daylight Saving Time	UTC - 4 hours
	CST	Central Standard Time	UTC - 6 hours
	CDT	Central Daylight Saving Time	UTC - 5 hours
	MST	Mountain Standard Time	UTC - 7 hours
	MDT	Mountain Daylight Saving Time	UTC - 6 hours
	PST	Pacific Standard Time	UTC - 8 hours
	PDT	Pacific Daylight Saving Time	UTC - 7 hours
	HST	Hawaiian Standard Time	UTC - 10 hours
	AKST	Alaska Standard Time	UTC - 9 hours
	AKDT	Alaska Daylight Saving Time	UTC - 8 hours

To select a different time zone

1. From standby mode, press **▲** menu.
2. Press **pqrs 7** Preferences.
3. Press **abc 2** Display.
4. Press **mno 6** TimeZone.
5. Press *** ↓** to select a time zone from the list. Press **↓ #** to move backward through the list.
6. Press **▲** ok.

SMS Time

The time stamp displayed for SMS messages (usually UTC, or universal coordinated time) can be changed to the same one displayed in the Time Zone function.

To set the SMS time stamp

1. From standby mode, press **▲** menu.
2. Press **pqrs 7** Preferences.
3. Press **abc 2** Display.
4. Press **pqrs 7** SMS Time.
5. Press *** ↓** or **↓ #** to select “adjust.” Press again to select “as received.”
 - As received – Time displays as received, probably in UTC format
 - Adjust – Changes to the time zone selected under Time Zone (see Globalstar Time Zone, page 59)
6. Press **▲** ok.

Language

Several languages are available to be displayed on your phone's screen.

To set the language

1. From standby mode, press **▲** menu.
2. Press **pqrs 7** Preferences.
3. Press **abc 2** Display.
4. Press **tuv 8** Language.
5. Press *** ↓** or **↓ #** to select from the list of available languages.
6. Press **▲** ok.

Alerts

For your convenience, alerts may be configured to produce a tone while flashing a message. The following alerts can be set to sound a tone:

- Fade
- Minute

- Service change
- New message

Fade

The fade alert occurs when any network drops a call.

To set the fade alert

1. From standby mode, press **▲** **menu**.
2. Press **(pqrs 7)** Preferences.
3. Press **(def 3)** Alerts.
4. Press **(1)** Fade.
5. Press **(* |)** or **(| #)** to select “on.” Press again to select “off.”
6. Press **▲** **ok**.

Minute

The minute alert occurs ten seconds before the end of every minute.

To set the minute alert

1. From standby mode, press **▲** **menu**.
2. Press **(pqrs 7)** Preferences.
3. Press **(def 3)** Alerts.
4. Press **(abc 2)** Minute.
5. Press **(* |)** or **(| #)** to select “on.” Press again to select “off.”
6. Press **▲** **ok**.

Service Change

The service change alert occurs when the phone enters or leaves service. This alert displays a message and can also be configured to sound a tone.

To set the service change alert

1. From standby mode, press **▲** **menu**.
2. Press **(pqrs 7)** Preferences.
3. Press **(def 3)** Alerts.
4. Press **(def 3)** Service.
5. Press **(* |)** or **(| #)** to select “on.” Press again to select “off.”
6. Press **▲** **ok**.

New Message

The new message alert occurs when you receive a new text message or voice mail notification.

To set the new message alert

1. From standby mode, press **▲** **menu**.
2. Press **(pqrs 7)** Preferences.
3. Press **(def 3)** Alerts.

4. Press **(ghi 4)** New Message.
5. Press **(* |)** or **(| #)** to select one of the following options:
 - Off – Phone does not sound a beep when a new message is received
 - Once – Phone sounds one beep when a new message is received
 - Periodic – Phone sounds a beep periodically when a new message is received until you retrieve the message by pressing **(☒)**
6. Press **(▲)** **ok**.

Calling

The following features can be configured to simplify the calling process:

- Auto Answer
- Auto Redial
- One-Touch Dial
- Any-Key Answer
- Send PIN

Auto Answer

Use this feature to adjust the number of times the phone rings before it automatically answers a call. When this auto answer feature is used, the phone's ringer option is automatically set to Standard.

To set auto answer

1. From standby mode, press **(▲)** **menu**.
2. Press **(pqrs 7)** Preferences.
3. Press **(ghi 4)** Calling.
4. Press **(1)** AutoAnswer.
5. Press **(* |)** or **(| #)** to select one of the following options:
 - Off – Phone does not automatically answer
 - After 1 ring – Phone automatically answers after 1 ring
 - After 2 rings – Phone automatically answers after 2 rings
 - Car kit only 1 ring – Phone automatically answers when installed in the car kit after 1 ring
 - Car kit only 2 rings – Phone automatically answers when installed in the car kit after 2 rings
6. Press **(▲)** **ok**.



Note

If you select an option other than “off,” the message “-Auto Answer-” flashes while in standby mode.

Auto Redial

Use this feature to set the time interval in which the phone automatically redials a number when the network is busy or unavailable, but not when the phone line is busy.

While the phone is in standby mode, the phone automatically redials at that interval until the call connects or you press **END**. If you change service, auto redial stops.

To set auto redial

1. From standby mode, press **▲** **menu**.
2. Press **pqrs 7** Preferences.
3. Press **ghi 4** Calling.
4. Press **abc 2** Auto Redial.
5. Press *** |** or **| #** to select one of the following options:
 - Off – Do not automatically redial
 - Every 10 seconds – Automatically redial every 10 seconds
 - Every 30 seconds – Automatically redial every 30 seconds
 - Every 60 seconds – Automatically redial every 60 seconds
6. Press **▲** **ok**.

One-Touch Dial

Use the one-touch dial feature to call any of the 99 phone book location numbers without pressing **SEND**.

To set one-touch dial

1. From standby mode, press **▲** **menu**.
2. Press **pqrs 7** Preferences.
3. Press **ghi 4** Calling.
4. Press **def 3** One-Touch Dial.
5. Press *** |** or **| #** to select “yes.” Press again to select “no.”
6. Press **▲** **ok**.

(See One-touch dialing, page 27, for more information.)

Any-Key Answer

If you prefer to answer an incoming call by pressing any key (except **Pwr** or **END**), set the any-key answer feature to “yes.”



Note

If this feature is not set to “yes,” press **SEND** to answer calls.

To set Any-Key Answer

1. From standby mode, press **▲** **menu**.
2. Press **pqrs 7** Preferences.
3. Press **ghi 4** Calling.
4. Press **ghi 4** AnyKeyAnsw.

5. Press ***** **1** or **1** **#** to select “yes.” Press again to select “no.”
6. Press **▲** **ok**.

Send PIN

If your cellular service provider supports this security feature, use a PIN (personal identification number) for verification before connecting analog calls. Contact your cellular service provider for your PIN. (See Entering PIN, page 50.)

Each PIN is associated with a different NAM (number assignment module), or phone number. When you enter a PIN, it becomes associated with the currently selected NAM, so be sure to select the appropriate NAM before configuring Send PIN (see NAM Select, page 76).

To set Send PIN

1. From standby mode, press **▲** **menu**.



Note

Be sure to select the appropriate NAM before setting Send PIN (see NAM Select, page 76).

2. Press **pqrs** **7** Preferences.
3. Press **ghi** **4** Calling.
4. Press **ijkl** **5** Send PIN.
5. Press ***** **1** or **1** **#** to select “Never.” Press again to select “Prompt.”
 - Never – Does not prompt you for or send a PIN
 - Prompt – Prompts you for a PIN after you enter the phone number
6. Press **▲** **ok**.

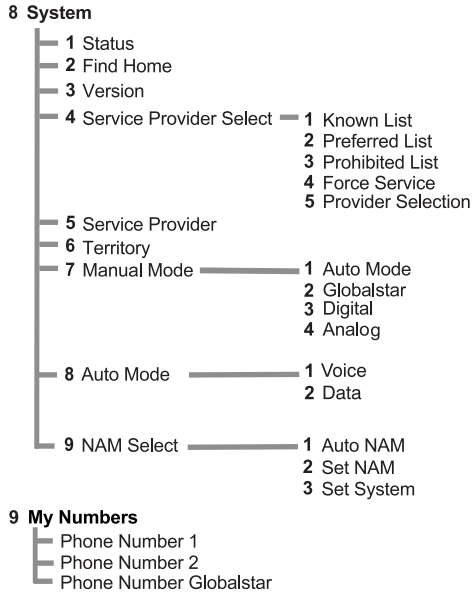

This section provides information on how to use the following system features:

- Status
- Find Home
- Version
- Service Provider Select
- Service Provider
- Territory
- Manual Mode
- Auto Mode
- NAM Select
- My Numbers

Status

When the phone is in Globalstar satellite mode, this feature provides status for the state of the phone's Globalstar satellite antenna, car kit, security module, battery, memory, lock, and self-test:

- ☺ Indicates a good condition or ready for use.
- ☹ Indicates a faulty condition or not ready for use.
- – Indicates not in use.

To access status information

1. From standby mode, press **▲** menu.
2. Press **8** System.
3. Press **1** Status:
 - Antenna Up – If ☺ displays, the Globalstar satellite antenna is rotated properly. If the antenna is rotated and ☹ displays, contact your satellite service provider.
 - Car Kit – If ☺ displays, the car kit is operating properly. If ☹ displays, reconnect the phone in the cradle or contact the installation technician.
 - Battery – If ☺ displays, the battery is installed properly. If ☹ displays, remove and replace your battery or contact your satellite service provider.
 - Security – If ☺ displays, the valid security module is inserted properly. (There may be a brief delay in displaying ☺.) If ☹ displays, contact your satellite service provider.
 - Memory – If ☺ displays, there is enough available phone memory. If ☹ displays, delete text messages and voice mail notifications.
 - Unlocked – If ☺ displays, the satellite or cellular service provider has not locked your phone. If ☹ displays, contact your service provider.
 - Self-test – If ☺ displays, the phone has made a successful self-test. If ☹ displays, contact your satellite or cellular service provider.
4. Press **Ctrl** or **END**.

Find Home

The Find Home feature quickly locates your home satellite service provider. If the home provider is not available, the phone searches for service based on mode priorities configured in the Auto Mode feature (see Auto Mode, page 73).

If the phone displays “Roam” while in the home area, use this Find Home feature to re-establish local service.



Tip

To eliminate “roaming” in your home area, use the Find Home feature before you place the call.

To force the phone to find home

1. From standby mode, press **▲** menu.
2. Press **8** System.
3. Press **2** Find Home.
4. Press **▲** ok.

Version

The Version feature displays the version number of the software installed on your phone.

To display the software version number

1. From standby mode, press **▲** **menu**.
2. Press **tuv 8** **System**.
3. Press **def 3** **Version**.
4. Scroll to read the information (see Navigating and using menus, page 20).
5. Press **Clr** or **END**.

Service Provider Select

The Service Provider Select feature accesses three lists of satellite service providers: Known, Preferred and Prohibited. This feature also allows you to select and force registration with a service provider.

Phone Registering

Registration means your phone is looking for and obtains service after network approval.

- If the service change alert is set to “on,” the alert sounds a tone and displays a menu when the phone enters or leaves service. (See Service Change, page 62.)
- After your phone is registered and an **i** displays on the screen, press **Info** for service provider information and the current phone number.

Changes made to the Preferred or Prohibited Lists do not take effect until the phone is registered again with the network. To register the phone, choose one of the following methods:

- Turn the phone on and off.
- Find your home satellite service provider (see Find Home, page 68).
- Force service provider selection (see Force Service Provider Selection, page 72).

If you add the currently registered satellite service provider to the Prohibited List, the phone automatically re-registers.

Service Provider Lists

- **Known List** – Displays all of the known satellite service providers that can be added to the Preferred or Prohibited Lists. This list is created and updated by the satellite service provider.
 - New satellite service providers are automatically added as they become available.
 - Satellite service providers placed on the Preferred List are highlighted.
 - Satellite service providers placed on the Prohibited List are crossed out.

- ❑ Satellite service providers placed on both the Preferred and Prohibited Lists are highlighted and crossed out.
- Preferred List – Displays your preferred order of priority for satellite service providers.
 - ❑ Highlighted first on the screen is your home satellite service provider.
 - ❑ The order of priority is shown by the number to the left of the satellite service provider's name.
- Prohibited List – Displays the satellite service providers (in alphabetical order) that you choose *not* to use.



Note

You cannot add or delete your home service provider from any list.

Viewing lists

To view the Known, Preferred, or Prohibited Lists

1. From standby mode, press **▲** **menu**.
2. Press **tuv 8** System.
3. Press **ghi 4** SP (service provider) Select.
4. To select a list to view:
 - Press **1** Known List.
 - Press **abc 2** Prefr List.
 - Press **def 3** Prohb List.
5. Press **▲** **view** to display the satellite service provider's MCC (mobile country code) and MNC (mobile network code).
 - If the satellite service provider is on the Preferred List, the preferred location number displays (Pref Loc).
 - If the satellite service provider is on the Prohibited List, "yes" displays (Prohib).
 - If the satellite service provider is on both the Preferred and the Prohibited Lists, the preferred location number and "yes" displays.
6. Press **▲** **ok**.

Adding to lists

To add to the Preferred or Prohibited Lists

1. From standby mode, press **▲** **menu**.
2. Press **tuv 8** System.
3. Press **ghi 4** SP (service provider) Select.
4. Press **1** Known List.
5. Scroll to select a satellite service provider (see Navigating and using menus, page 20).
6. Press **▲** **edit**.

7. Press **1** Preferred or **abc 2** Prohibited.
8. Press **▲** **ok**.
9. Re-register your phone (see Phone Registering, page 69).

Editing lists

To edit (reorder or delete) from the Preferred List

1. From standby mode, press **▲** **menu**.
2. Press **tuv 8** System.
3. Press **ghi 4** SP (service provider) Select.
4. Press **abc 2** Prefr List.
5. Scroll to select a satellite service provider.
6. Press **▲** **edit**.
7. Choose *one* of the following:
 - Reorder
 - Press **1** Reorder
 - Scroll to move the selected satellite service provider to a new position in the Preferred List.
 - Press **▲** **ok**.
 - Delete
 - Press **abc 2** Delete.
 - Press **▲** **ok** to delete the selected satellite service provider from the Preferred List.
8. Press **▲** **ok**.
9. Re-register your phone (see Phone Registering, page 69).

Erasing a provider from the Prohibited List

To erase an item from the Prohibited List

1. From standby mode, press **▲** **menu**.
2. Press **tuv 8** System.
3. Press **ghi 4** SP (service provider) Select.
4. Press **def 3** Prohb List.
5. Scroll to select a satellite service provider.
6. Press **▲** **erase**.
7. Press **▲** **ok**.
8. Re-register your phone (see Phone Registering, page 69).

Force Service Provider Selection

This feature forces the phone to register with a satellite service provider in the following order of priority:

1. The phone attempts to register with your home satellite service provider.
2. The phone attempts to register with satellite service providers on the Preferred List.
3. The phone attempts to register with satellite service providers on the Known List.

To force satellite service provider selection

1. From standby mode, press **▲** **menu**.
2. Press **tuv 8** **System**.
3. Press **ghi 4** **SP (service provider) Select**.
4. Press **ghi 4** **Force SPS (service provider selection)**.
5. Press **▲** **ok**.

Service Provider

To display the current satellite service provider's name

1. From standby mode, press **▲** **menu**.
2. Press **tuv 8** **System**.
3. Press **jkl 5** **SrvcPrvder**.
4. Press **Clr** or **END**.

Territory

This feature displays the current satellite service provider's MCC (mobile country code) and MNC (mobile network code).

To display the territory information

1. From standby mode, press **▲** **menu**.
2. Press **tuv 8** **System**.
3. Press **mno 6** **Territory**.
4. Press **Clr** or **END**.

Manual Mode

The phone operates in Globalstar satellite service mode or cellular service mode (digital or analog). Use the Manual Mode feature to select one of these modes. Select Auto Mode to configure the automatic mode-switching feature (see Auto Mode, page 73).



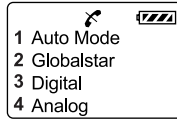

The mode selected remains active until you turn the phone off, and then it resets to the Auto Mode setting. If one of the modes is currently unavailable, it does not display on the screen.

To manually select a mode

1. **Shortcut:** From standby mode, press and hold . The following displays:



2. Press:

-  to select Auto Mode. The message “Initiating Automatic System Acquisition” displays.
-  for Globalstar satellite mode. The message “Initiating Globalstar System Acquisition” displays.
-  for Digital mode. The message “Initiating Digital System Acquisition” displays.
-  for Analog mode. The message “Initiating Analog System Acquisition” displays.

Auto Mode

The Auto Mode feature can be configured for both voice and data calls. This feature allows the phone to switch from satellite to cellular mode as necessary.

For example, the Voice mode is set to GStar Prefer, indicating that satellite service is the preferred choice. If Globalstar satellite service is not available, the Auto Mode feature automatically switches the phone to cellular service. To completely automate the phone, select Current when configuring the Data mode. Data calls are then sent using the Voice service currently in use, whether it be Globalstar satellite or cellular digital.

Voice

To configure the Voice option, set each phone number (or NAM) to automatically look for service using the order of mode priority that you specify:

- GStar only – Searches for Globalstar satellite service only.
- Cell only – Searches for cellular service, either digital or analog mode as indicated by the Cell Pref configuration.
- GStar Pref – Searches for Globalstar satellite service first and cellular service last.
- Cell Pref – Searches for cellular service first and Globalstar satellite service last.

To set voice auto mode

1. Select the appropriate NAM (see NAM Select, page 76).
2. From standby mode, press **▲ menu**.
3. Press **tuv 8 System**.
4. Press **tuv 8 Auto Mode**.
5. Press **1 Voice**.
6. Scroll to select one of the following:
 - **GStar Only** – Search for Globalstar satellite service only.
 - Press **▲ ok**.
 - The phone returns to standby mode.
 - **Cell Only** – Search for cellular service only.
 - Press **▲ ok**.
 - The Cell Pref menu displays.
 - Go to Step 7.
 - **GStar Pref** – Search for Globalstar satellite service first and cellular service last.
 - Press **▲ ok**.
 - The Cell Pref menu displays.
 - Go to Step 7.
 - **Cell Pref** – Search for cellular service first and Globalstar last.
 - Press **▲ ok**.
 - The Cell Pref menu displays.
 - Go to Step 7.
7. If the Cell Pref menu displays, select one of the following:
 - **Analg Only** – Prefer analog service only
 - **Digtl Only** – Prefer digital service only
 - **Digtl Pref** – Prefer digital service over analog
 - **Analg Pref** – Prefer analog service over digital
8. Press **▲ ok**.

Data

The Data option allows the user to configure the phone for Data service (either packet data or async data). If your service provider offers this option, data calls can be made in the Globalstar satellite or the cellular digital mode.

To use the Auto Mode feature to send data calls, select:

- **Current** – Places a data call by automatically selecting the service currently “in use” by the Voice option. This could be Globalstar satellite or cellular service.

**Note**

When sending a data call using cellular service, be sure a digital mode is selected in the Voice option.





Other data modes available:

- None – Restricts data calls.
- GStar Only – Allows data calls using Globalstar satellite service only. If the user tries to make a data call while the phone is *not* in Globalstar mode, the phone attempts to acquire the Globalstar satellite system and place the data call.
- Cell Only – Allows data calls using cellular digital service only. If the user tries to make a data call while the phone is *not* in cellular digital mode, the phone attempts to acquire cellular digital service and place the data call.

**Tip**

The Voice option controls the service mode. If the Data option is not in the Current mode, be sure to return to the Voice option to select a compatible mode. If compatible Voice and Data modes are not selected, a message displays.

To set data auto mode

1. Select the appropriate NAM (see NAM Select, page 76).
2. From standby mode, press  menu.
3. Press  System.
4. Press  Auto Mode.
5. Press  Data.
6. Select the following:
 - Current – Place a data call by automatically selecting the service currently “in use” by the Voice option. This could be Globalstar satellite or cellular service.
 - None – Restrict data calls
 - GStar Only – Place the data call using Globalstar satellite service only.
 - Cell Only – Place the data call using cellular digital service only.
7. Press  **ok**. The phone returns to standby mode.

**Note**

Packet data is supported in both Globalstar satellite and digital cellular modes. Async data is supported in the Globalstar mode only.

NAM Select





The NAM Select feature activates a number assignment module (NAM). The phone allows one Globalstar phone number or NAM (number assignment module), and two different cellular-only NAMs. The NAMs are entered into the phone by your service providers. (See My Numbers, page 77, to display the NAMs entered.)

Before making or receiving calls, you must activate a NAM, but only one can be active at a time. Choose one of these options:





- Auto NAM – Automatically switches NAMs, if appropriate, during system searches to look for home area service.
- Set NAM – Manually sets the NAM.
- Set System – Sets your system preference for each cellular NAM. It does not affect Globalstar service.

Your service provider can configure the Globalstar NAM for both Globalstar and cellular service (digital and analog). In Globalstar mode, the phone always uses the Globalstar NAM. In cellular mode, the phone uses the selected cellular NAM (NAM1, NAM2, or G*NAM).





To set Auto NAM

1. From standby mode, press  **menu**.
2. Press  System.
3. Press  NAM Select.
4. Press  Auto NAM.
5. Scroll to select “yes” or “no.”
6. Press  **ok**.

To set the NAM

1. From standby mode with Auto NAM set to “no,” press  **menu**.
2. Press  System.
3. Press  NAM Select.
4. Press  Set NAM.
5. Scroll to select the NAM.
6. Press  **ok**.

To set the system

1. Select the appropriate NAM (see NAM Select, page 76).
2. From standby mode, press  **menu**.
3. Press  System.
4. Press  NAM Select.
5. Press  Set System.
6. Scroll to select one of the following:
 - Automatic – Use home system, but if not found use another system

- No Roaming – Use only the home system
- A only – Use cellular “A” system only
- B only – Use cellular “B” system only



My Numbers

9 My Numbers

- Phone Number 1
- Phone Number 2
- Phone Number Globalstar

This feature displays your three phone numbers (NAMs) and service provider name. The NAMs are entered by your service provider, (see NAM Select, page 76).

To display your three phone numbers

1. From standby mode, press  menu
2. Press  My Numbers.
3. Scroll to select one of the following:
 - PhoneNo 1 – Displays cellular phone number
 - PhoneNo 2 – Displays cellular phone number
 - PhoneNo G* – Displays Globalstar satellite phone number

Battery Care and Maintenance

This section contains information about the care and maintenance of the tri-mode phone batteries.

- Battery care and charging
- Battery chargers
- Low battery
- Battery removal
- Battery replacement

A rechargeable battery is located on the back of the phone.

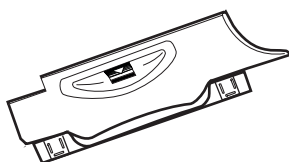

The following is typical battery performance:

Service Mode	Talk Time	Standby Time
Globalstar satellite	3.5 hours	9 hours
Digital	4.5 hours	72 hours
Analog	2.5 hours	14 hours

Battery care and charging

The battery charge level indicator is shown at the top right of the screen and ranges between four diagonal bars (full charge) to one bar (minimal charge). If the indicator has one blinking bar, the battery has no charge.



Fully charge the battery immediately after purchasing the phone to maximize the talk and standby times. The battery does not need to be completely drained before recharging. (See Low battery, page 81, for more information.)

Follow these guidelines for batteries:

- Only use QUALCOMM batteries and chargers designed for this phone. Only QUALCOMM batteries are designed to prevent overcharging. Do not use any other battery or charger.

- To maximize battery life, set the backlight option to “off” (see Backlight, page 57).
- To prevent damage, do not charge the battery in temperatures less than +32 °F (0 °C) or greater than +104 °F (+40 °C).
- Do not use the battery in temperatures less than -4 °F (-20 °C) or greater than +140 °F (+60 °C).
- Do not use the battery charger in direct sunlight or in places with excessive humidity, such as a bathroom.
- Keep the metal contacts at the top end of the battery clean.
- Never dispose of the battery in a fire or trash compactor.
- Do not try to disassemble or short circuit the battery.
- Recharge the battery if the phone has not been used for several months.
- Do not store batteries in places where temperatures are below -22 °F (-30 °C) or above +140 °F (+60 °C).

Battery chargers

There are three (3) battery charger options available (see Accessories, page 87):

- AC wall charger
- Universal travel charger
- Cigarette lighter adapter



Note

When using the AC wall charger, plug the charger into the power source first, and then into the phone.

About battery charging

- The battery recharges while in use.
- For faster charging, turn the phone off.
- The battery does not need to be completely drained before recharging.
- The typical charge time to 90% charge level for the universal travel charger, cigarette lighter adapter, or AC wall charger is 2-1/2 hours.
- After connecting the phone to one of the chargers, check the charging status:
 - If the battery is charging, a message displays and the bars on the battery indicator  flash in sequence.
 - If the phone is turned off, a message displays on the screen when charging is complete.
- The universal travel charger allows you to:
 - Charge the battery while it is attached to the phone.
 - Charge the battery during use or when turned off.
 - Charge another battery at the same time.

Low battery

The phone alerts you when the battery is low.

- The battery indicator flashes.
- The phone beeps three times (if you are on a call, the phone continues to beep every minute).
- The message “Low Battery! Recharge Battery Soon” displays on the screen.
- If the battery level gets too low, the phone turns off and loses any call in progress.
 - Before turning off, the phone alerts you with five beeps.
 - The message “Low Battery, Turning Off Phone Now” displays on the screen.



Tip

To turn off the battery alert, set the ringer volume to zero (0).

Battery removal

To remove the battery, complete the following steps.

1. Turn the power off to avoid losing data.
2. Press and hold the battery release latch in the direction of the arrow to release it from the phone.

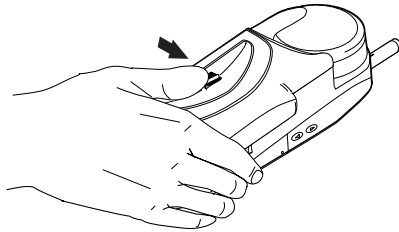

Battery replacement

To replace the battery, complete the following steps:

1. If a battery is already installed, turn the power off to prevent losing data and then remove the battery (see Battery removal, page 81).
2. Insert the new replacement battery by lining up the positioning tabs (see arrows in illustration) and rotating it into place.

3. Press down on the battery until it locks.

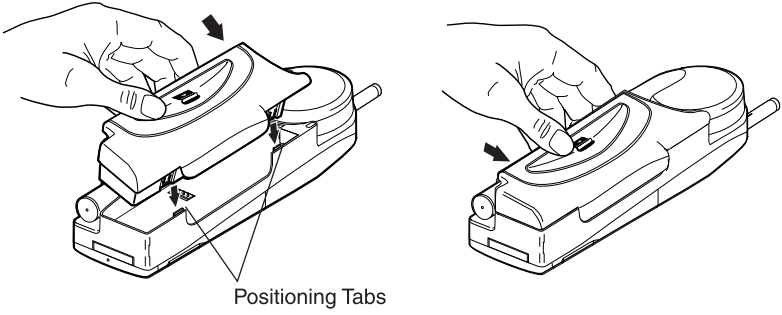

This section contains the following safety information for wireless handheld phones:

- Exposure to radio frequency signals
- Antenna care
- Phone operation
- Driving
- Electronic devices
- Aircraft
- Blasting areas
- Potentially explosive atmospheres
- For vehicles equipped with an air bag
- Battery care
- Other safety issues

Exposure to radio frequency signals

Your wireless handheld portable telephone is a low power radio transmitter and receiver. When it is on, it receives and also sends out radio frequency (RF) signals.

In August, 1996, the Federal Communications Commissions (FCC) adopted RF exposure guidelines with safety levels for hand-held wireless phones. These guidelines are consistent with the safety standards previously set by both U.S. and international standards bodies:

- ANSI C95.1 (1992)¹
- NCRP Report 86 (1986)²
- ICNIRP (1996)³

These standards are based on comprehensive and periodic evaluations of the relevant scientific literature. For example, over 120 scientists, engineers, and physicians from universities, government health agencies, and industry reviewed the available body of research to develop the ANSI Standard (C95.1).

The design of your phone complies with the FCC guidelines (and those standards).

1.American National Standards Institute

2.National Council on Radiation Protection and Measurements

3.International Commission on Non-Ionizing Radiation Protection

Antenna care

Use only the supplied or an approved replacement antenna. Unauthorized antennas, modifications, or attachments could damage the phone and may violate FCC regulations.

Phone operation

Hold the phone as you would any other telephone with the antenna pointed up and over your shoulder.



Tip

For your phone to operate most efficiently:

- ❑ Extend your antenna fully.
- ❑ Do not touch the antenna unnecessarily when the phone is in use. Contact with the antenna affects call quality and may cause the phone to operate at a higher power level than otherwise needed.

Driving

In the areas where you drive, always obey the local laws and regulations on the use of wireless telephones.

If using your phone while driving, please:

- Give full attention to driving – safely is your first responsibility.
- Use hands-free operation, if available.
- Pull off the road and park before making or answering a call if driving conditions so require.

Electronic devices

Most modern electronic equipment is shielded from RF signals. However, certain electronic equipment may not be shielded against the RF signals from your wireless phone.

Pacemakers

The Health Industry Manufacturers Association recommends that a minimum separation of six (6") inches be maintained between a handheld wireless phone and a pacemaker to avoid potential interference with the pacemaker. These recommendations are consistent with the independent research by and recommendations of Wireless Technology Research.

When wearing a pacemaker:

- Always keep the phone more than six inches from the pacemaker when the phone is turned on.
- Do not carry the phone in a breast pocket.

- Use the ear opposite the pacemaker to minimize the potential for interference.
- If you have any reason to suspect that interference is taking place, turn your phone off immediately.

Hearing aids

Some digital wireless phones may interfere with some hearing aids. In the event of such interference, you may want to consult your service provider.

Other medical devices

If you use any other personal medical device, consult the manufacturer of your device to determine if it is adequately shielded from external RF energy. Your physician may be able to assist you in obtaining this information.

Turn your phone off in health care facilities when any regulations posted in these areas instruct you to do so. Hospitals or health care facilities may be using equipment that could be sensitive to external RF energy.

Vehicles

RF signals may affect improperly installed or inadequately shielded electronic systems in motor vehicles. Check with the manufacturer or its representative regarding your vehicle. You should also consult the manufacturer of any equipment that has been added to your vehicle.

Posted facilities

Turn your phone off in any facility where posted notices so require.

Aircraft

FCC regulations prohibit using your phone while in the air. Switch off your phone before boarding an aircraft.

Blasting areas

To avoid interfering with blasting operations, turn your phone off when in a “blasting area” or in areas posted: “Turn off two-way radio”. Obey all signs and instructions.

Potentially explosive atmospheres

Turn your phone off when in any area with a potentially explosive atmosphere. Obey all signs and instructions. Sparks in these areas could cause an explosion or fire resulting in bodily injury or even death.

Areas with a potentially explosive atmosphere are often but not always clearly marked. They include fueling areas such as gasoline stations; below deck on boats; fuel or chemical transfer or storage facilities; vehicles using liquefied petroleum gas (such as propane or butane); areas where the air contains chemicals or particles, such as grain, dust, or metal powders; and any other area where you would normally be advised to turn off your vehicle engine.

For vehicles equipped with an air bag

An air bag inflates with great force. Do not place objects, including both installed or portable wireless equipment, in the area over the air bag or in the air bag deployment area. If in-vehicle wireless equipment is improperly installed and the air bag inflates, serious injury could result.

Battery care

The phone's battery stores a large amount of energy when fully charged. If the battery is punctured, crushed, severely overheated, or charged in a non-QUALCOMM charger, this energy can be released suddenly and result in potential injury.

- Do not overheat the battery by leaving it on a heater or in the sun.
- Do not dispose of the battery in a trash compactor or incinerator.
- Use only charging accessories manufactured by QUALCOMM, and discontinue use of the battery if it becomes damaged.

Other safety issues

In order to avoid the potential for confusing the phone as a weapon, the phone features a distinctive flame orange band at the tip of the antenna.

- This orange band is a convention used by manufacturers of various devices and is familiar to safety officers in the country of manufacture and other countries.
- Do not remove or cover the band, and avoid using or handling the phone in a threatening manner or so as to suggest that the phone is a weapon.

The optional accessories described in this section are available from your satellite or cellular service provider.



Caution

Allow only authorized personnel to service the accessories.
Unauthorized service can invalidate the warranty.

Battery

An extra battery allows you to have a charged battery available at all times.

Leather case

A leather case with a wrist strap protects your phone and provides carrying convenience.

AC wall charger

The North American, European and Argentine version AC wall chargers supply power to the phone and fast charge the battery while it is attached to the phone. All chargers operate at 110 V and 220 V.

Universal travel charger

The universal travel charger allows you to charge a battery attached to the phone. At the same time, you can charge a battery detached from the phone and installed in the universal travel charger. Three optional plugs are available to adapt the universal travel charger for use in different countries.

Cigarette lighter adapter

The cigarette lighter adapter supports both U.S. and European vehicles. For European vehicles, insert the adapter into the sleeve.

Plug the adapter into your vehicle's cigarette lighter to supply power to the phone (with or without the battery attached). You can also fast charge the battery at the same time.

Data cables

Various data cables or adaptors are available that allow you to connect your phone directly to IBM® PC-compatible computers, Apple® Macintosh® computers, Palm™ handheld organizers, or UNIX®-based computers. See the QUALCOMM Globalstar packet data kit user documentation that comes with your data cable for more information.

Hands-free car kit

With the QUALCOMM Globalstar Hands-Free Car Kit, you can adapt your phone for hands-free operation in your vehicle. For more information, see the QUALCOMM Globalstar hands-free car kit user documentation.



Caution

Allow only authorized personnel to install or service the car kit. Faulty installation or service can be dangerous and can invalidate the warranty.

Troubleshooting

This section provides information to help troubleshoot your phone.

If the problems with your phone are not resolved by following these troubleshooting tips, contact your satellite or cellular service provider. (You may have different service providers for Globalstar satellite service and cellular service.)

Problem	Solution
Turning the phone on	<ul style="list-style-type: none">■ Hold  for more than one second.■ Check the battery installation.■ Recharge or replace the battery.
Charging the battery	<ul style="list-style-type: none">■ Install only QUALCOMM batteries.■ Check that the battery contacts are clean and dry.■ Check the charger connection.■ If the battery does not charge at first, remove the charger plug from the phone, wait ten seconds, and then reinsert the plug.■ Check the battery temperature. If it is too warm, allow it to cool before recharging it.■ Replace the battery if it is several years old.
Battery draining quickly	<ul style="list-style-type: none">■ Check that your Globalstar satellite antenna is pointing straight up and has a clear view of the sky to conserve battery life.■ Set the backlight option to “off” (see Backlight, page 57).■ Replace the battery if it is several years old.■ Check the battery temperature. If temperatures are too warm or too cold, battery life is decreased.

Problem	Solution
Making calls	<ul style="list-style-type: none"> ■ Rotate or fully extend the appropriate antenna. ■ In Globalstar satellite mode, be sure the satellite antenna has a clear view of the sky. ■ Check that the correct service mode is selected: <ul style="list-style-type: none"> ■ In standby mode, press and hold (* ↑) to display the mode menu. ■ Press (abc 2) Globalstar for satellite service. ■ Press (def 3) Digital or (ghi 4) Analog for cellular service. ■ Remove all service providers from the Prohibited List (see Erasing a provider from the Prohibited List, page 71). ■ If “Service Not Found” displays, check the auto preference and mode selection settings (see Auto Mode, page 73, and Manual Mode, page 72). ■ Check the signal strength indicator. ■ Check that the security module is properly installed. If the security module was removed, turn the phone off and on. ■ If “Calling is Restricted” displays, check the Restrict Phone setting under the Security menu (see Restricting the phone, page 48.)

Problem	Solution
Receiving calls	<ul style="list-style-type: none"> ■ Check that the phone is turned on. ■ Check that the ringer is loud enough. ■ Rotate or fully extend the appropriate antenna. In Globalstar satellite mode, be sure that the satellite antenna has a clear view of the sky. ■ Check that the correct service mode is selected: <ul style="list-style-type: none"> ■ Press and hold (*) 1 to display the mode menu. ■ Press (abc) 2 Globalstar for satellite service. ■ Press (def) 3 Digital or (ghi) 4 Analog for cellular service. ■ Remove all service providers from the Prohibited List (see Erasing a provider from the Prohibited List, page 71). ■ Check the signal strength indicator. ■ Check that the security module is properly installed. If the security module was removed, turn the phone off and on.
Losing calls	<ul style="list-style-type: none"> ■ In Globalstar satellite mode, be sure that your satellite antenna is pointing straight up when placed next to your head and when using the keypad or viewing the screen. ■ In Globalstar satellite mode, be sure that the satellite antenna has a clear view of the sky. ■ Rotate or fully extend the appropriate antenna. ■ Check the signal strength indicator.
Remembering your lock code or PIN (personal identification number)	<ul style="list-style-type: none"> ■ Contact your satellite or cellular service provider for the lock code for the Security menu or phone lock feature. ■ Contact your cellular service provider for the PIN used to make analog calls.

Third Party Equipment

QUALCOMM has tested and approved ONLY the third party product(s) mentioned in this appendix. The product(s) listed below may be used with the QUALCOMM Globalstar GSP-1600 Tri-Mode Phone at the user's discretion. All warranties and instructions for use are provided by the supplier of such product(s). The user should follow the instructions for use provided by the supplier of such product(s) in order to achieve the intended results.

Product: SunWize (TM) Portable Energy System

1. SunWize Portable Energy System Model PES-QM
2. SunWize Portable Energy System Doubler Model PES-2-QM

Contact SunWize for more detailed information, including pricing and availability.

SunWize Technologies, Inc.
1155 Flatbush Road
Kingston, NY 12401
Telephone number: (845) 336-0146
Web Site: www.sunwize.com

- A**
- AC wall charger 87
- access scratchpad 40
- access text messages 35
- Accessories
 - Battery 87
 - Cigarette lighter adapter 87
 - Data cables 87
 - Leather case 87
 - Universal travel charger 87
- adaptors, data 87
- adjust the earpiece volume 55
- air bag safety 86
- Alerts
 - fade 61
 - minute 62
 - new message 62
 - service change 62
- all calls 44
- analog mode indicator 9
- Antenna 11
- antenna
 - cellular 5
 - safety 84
 - satellite 2, 3
- any-key answer 64
- auto answer 63
- auto data mode 75
- auto hyphen
 - pauses 22
- auto hyphens 58
- Auto Mode
 - Data 74
 - Voice 73
 - voice 74
- auto NAM 76
- B**
- backlight
 - settings 57
- Banner
 - edit 58
- Battery
 - charge indicator 79
 - charge time 80
 - charger indicator 9
 - chargers 80
 - charging 79
 - decrease life 57
 - guidelines 79
 - increase life 57
 - low charge 81
 - removal 81
 - replacement 81
 - typical performance 79
- C**
- Call history
 - accessing 30
 - Date/Time 31
 - Duration 31
 - Prepend 31
 - Save 31
 - Send 31
 - Send tones 31
 - View # 31
 - viewing details 30
- Call history list
 - erasing 49
- call in progress indicator 9
- Call information
 - all calls 44
 - data calls 44
 - home calls 43
 - last call 43
 - recent calls 44
 - roam calls 44
- Call waiting 17
- Caller ID 18
- Calling basics
 - Call waiting 17
 - Caller ID 18
 - Edit numbers 15
 - International dialing 17
 - Making emergency calls 15
 - Muting a call 17
 - Position location service 17
 - Standby mode 14
 - Three-way calling 18
 - Turning the phone on 13
- Calls
 - emergency 15, 16
 - making satellite calls 4
 - missed 6
 - mute 17
 - redialing 17
- cellular antenna 11
 - extending 5
- cellular mode 1, 72, 73
- charger
 - universal travel 87
 - wall 87

- charging battery 79, 80
- check mark indicator 10
- cigarette lighter adapter 87
- clear key
 - defined 8
- counter
 - resetting 45
 - undo resetting 45
- Current position coordinates 40

D

- data cables 87
- data calls 44
 - adaptors 87
 - data cables 87
 - making 5
 - set baud rate 41
- Deleting
 - letters 22
 - numbers 15
- digital mode indicator 9
- displaying phone number 6
- document conventions 2
- Download current location 17
- driving safety 84
- DTMF tones 26, 31

E

- Earpiece volume 54
- edit an entry 24
- Edit the banner 58
- editing
 - banner 58
 - letters 22
 - numbers 15
 - phone book entries 24
- electronic devices 84
- Emergency calls 15
 - callback waiting state 16
 - digital or analog 15
 - Emergency mode 16
 - Emergency numbers 16
 - Globalstar mode 15
 - Locking or restricting 16
- encryption 10
- end key 20
 - defined 8
- ending calls 6
- Entering
 - hyphens 58
 - hyphens, manually 59
 - letters 21

- numbers 14
- pauses 22
- priority numbers 49
- punctuation 22
- spaces 22

- Entering letters and other characters 21

Erasing

- all phone book entries 49
- all SMS messages 50
- call history list 49
- phone book entries 25

F

- fade 62
- fade alert 62
- Features
 - Data speed 41
 - Key guard 39
 - scratchpad 39
- find an entry 24
- find home 68
- finding phone book entries 24
- force service provider selection 72

G

- Getting started
 - document conventions 2
 - Making cellular calls 4
 - Making satellite calls 4
 - Preparing for satellite calls 2
 - Receiving satellite or cellular calls 5
 - Understanding this guide 2
 - Understanding your phone 1
- Globalstar satellite mode 1, 73
- Globalstar time zone 59, 61

H

- hands-free car kit 88
- hard pauses 22
- hearing aids 85
- home calls 43
- hyphens
 - entering automatically 58

I

- incoming call ringer 54
- indicator
 - analog mode 9
 - battery charge 9
 - call in progress 9

- check mark 10
- digital mode 9
- light, defined 7
- locked message 10
- no service 9
- roaming 9
- satellite mode 9
- scroll arrows 10
- signal strength 9
- text message 9
- unlocked message 10
- voice message 9

Information key 8, 10

International dialing

- Globalstar satellite mode 17

K

Key beep

- Length 55
- sound 55
- volume 55

Key guard

- turn off 39
- turn on 39

key pad

- clear 8
- end 8
- information 8
- message 8
- punctuation 8
- scroll 8
- send 8
- smart key buttons 8
- smart key options 8

key presses 2

known list 69

L

Language 61

last call 43

lists

- known 69
- preferred 70
- prohibited 70

lock code, about 47

lock code, changing 47

Lock your phone 39

locked message indicator 10

locking messages 36, 37

locking phone 48

M

Main menu

- accessing 20
- Navigating and using menus 20
- return to previous screen 20
- return to standby mode 20

make international calls 17

manual mode 72, 73

- shortcut 2

medical devices 85

Memory

- text message 36

menu

- Accessories 87
- Call history 29
- Call information 43
- Calling basics 13
- Features 39
- Getting started 1
- Messages 33
- Phone basics 7
- Phone book 21
- Preferences 53
- Security 47
- System 67
- Troubleshooting 89

Messages

- access text 35
- call back numbers 35
- calling voice mail system 34
- erasing text 36
- locking 36, 37
- storing 36
- text 35
- unlocking 37
- voice mail notifications 34

minute alert 62

mode

- cellular 1, 72, 73
- power save 14
- satellite 1, 73
- standby 13, 14

mute phone 17

- turn on and off 17

mute stereo 56

my numbers 77

N

NAM Select

- setting auto NAM 76
- setting NAM 76
- setting system 76

- Navigating menus 20
 - previous screen 20
 - saving menu changes 20
 - standby mode 20
- new message alert 62
- no service indicator 9
- numbers
 - deleting 15
 - editing 15
 - entering 14
- O**
- one-touch dial
 - setting 64
 - using 27
- out of memory 36
- P**
- pacemakers 84
- Pauses
 - entering 22
 - entering numbers 23
 - hard 22
 - timed 22
- Phone basics
 - Antenna 11
 - Display indicators 9
 - Information key 10
 - Security module 10
- Phone book
 - editing entries 24
 - erasing all entries 49
 - erasing entries 25
 - finding entries 24
 - saving entries 23
 - secret entries 25
 - view or change secret entries 26
 - viewing numbers 26
- Phone Features
 - Battery 9
 - Battery release latch 9
 - Cellular antenna 8
 - Clear key 8
 - Display indicators 8
 - earpiece 7
 - End key 8
 - Globalstar satellite antenna 9
 - Message key 8
 - Microphone 9
 - Mode select 8
 - plus (+) key 8
 - Power key 9
 - Punctuation key 8
 - Scroll keys 8
 - Security module 8
 - Send key 8
 - Smart Key buttons 8
 - Smart Key options 8
 - volume buttons 8
- phone lock 48
- phone number, displaying 6
 - PIN
 - entering 50, 51
 - sending 65
 - plus key dialing 17
- Position location service 17
- Preferences
 - Alerts 61
 - Any-key answer 64
 - Auto answer 63
 - Auto hyphens 58
 - Backlight 57
 - Banner 58
 - Calling 63
 - Display 56
 - Key beep 55
 - Language 61
 - Manual hyphens 58
 - Mute stereo 56
 - one-touch dialing 64
 - Ringer type 54
 - ringer volume 54
 - Sending PIN 65
 - Show time 59
 - SMS time 61
 - Sort book 57
 - Sounds 53
- preferred list 70
 - adding 70
 - deleting 71
 - editing 71
 - reordering 71
 - viewing 70
- Prepend
 - add numbers 27
- priority numbers 49
- privacy 10
- prohibited list 70
 - adding 70
 - erasing 71
 - viewing 70

R

- radio frequency 83
- receiving calls 5
- recent calls 44
- redial
 - auto 64
 - manual 17
- removing battery 81
- reordering preferred list 71
- replacing battery 81
- resetting call counters 45
- resetting preferences 50
- restricting phone 48
- Ringer
 - incoming call 54
 - silencing 54
 - types 54
 - volume 54
- ringer type 54
- ringer volume 54
- roam calls 44
- roaming 4
 - indicator 9
- running out of memory 37

S

- Safety
 - air bags 86
 - aircraft 85
 - antenna 84
 - blasting areas 85
 - driving 84
 - electronic devices 84
 - explosive atmospheres 85
 - hearing aids 85
 - hospitals 85
 - medical devices 85
 - pacemakers 84
 - radio frequency 83
- satellite antenna 2, 3, 11
- satellite calls
 - making 4
 - preparing for 2
- satellite mode 1, 73
- satellite mode indicator 9
- Saving entries
 - name and phone number 23
- Scratchpad 39
- scroll arrows 10
- scroll keys 2, 8
- secret entries 25
- secret function

- configure 25

Security

- enter PIN 50, 51
- erase call history list 49
- erase phone book 49
- erase SMS messages 50
- lock phone 48
- new code 47
- priority numbers 49
- resetting preferences 50
- restricted 48
 - unlock phone 48
- security module 2, 10
- sending PIN 65
- sending tones 26
 - call history 31
 - manually 27
 - saved in phone book 27
 - scratchpad 40

Service

- registered 14
- service alert 62
- service provider
 - accessing information 72
 - force selection 72
 - select 69
- set auto hyphen 58
- set the backlight 57
- set the baud rate 41
- set the key beep length 56
- set the phone book sort order 57
- set up your personal sound preferences 53
- set voice auto mode 74
- Show time 59
- signal strength indicator 9
- silence the ringer 54
- SMART KEY options 2, 8
- SMS messages
 - erasing entries 50
- SMS time 61
- software version 69
- Sort book
 - settings 57
- Speed dialing
 - phone number 27
- standby mode 13
- standby time 79
- status 68
- System
 - auto mode 73

- auto voice mode 74
- Data auto mode 75
- Find home 68
- Force service provider selection 72
- manual mode 72, 73
- My numbers 77
- NAM select 76
- Service provider 72
- Service provider lists 69
- Service provider select 69
- status 67
- Territory 72
- Version 69

- voice mail 34
- voice mail notifications 34
- voice message indicator 9
- voice messages 33
- volume buttons 8

T

- talk time 79
- territory 72
- text message indicator 9
- Three-way calling 18
- time
 - showing 59
 - SMS 61
- time zone, Globalstar 59, 61
- timed pauses 22
- tones
 - DTMF 26
 - sending 26
 - sending by phone book 27
 - sending manually 27
- Troubleshooting 89
 - Battery draining quickly 89
 - Charging the battery 89
 - Losing calls 91
 - Making calls 90
 - Receiving calls 91
 - Remembering lock code or PIN 91
 - Turning the phone on 89
- Turning phone on 13

U

- Understanding this guide 2
- Understanding your phone 1
- undo counter 45
- universal travel charger 87
- unlocked message indicator 10
- unlocking messages 37
- unlocking phone 48

V

- viewing numbers 26